



# Centrifuge 5804/5804 R/5810/5810 R

Operating manual



Register  
your instrument!

[www.eppendorf.com/myeppendorf](http://www.eppendorf.com/myeppendorf)

*my*eppendorf

# eppendorf



Copyright © 2012 Eppendorf AG, Hamburg. No part of this publication may be reproduced without the prior permission of the copyright owner.

**Trademarks**

eppendorf and CombiSlide are registered trademarks of Eppendorf AG, Hamburg, Germany.

Centriplus is a registered trademark of Millipore Corporation, Billerica, USA.

Microtainer is a registered trademark of Becton Dickinson, Franklin Lakes, NJ, USA.

Trademarks are not marked in all cases with <sup>TM</sup> or ® in this manual.

You will find a detailed description of these figures in your language in Chapters 2.1 and 5.1.



|  |                     |
|--|---------------------|
| 1 Centrifuge lid   | 2 Monitoring glass  |
| 3 Control panel with display                               | 4 Emergency release |
| 5 Condensation water tray (only Centrifuge 5804 R/ 5810 R) |                     |

| Task/function                              | Press  | Display  | Details                              |
|--|--|--|--------------------------------------|
| Set parameter                              | <ol style="list-style-type: none"> <li>Press <b>speed</b> or <b>time</b> etc.</li> <li>Press <b>▲</b> or <b>▼</b>.</li> </ol>                | <ol style="list-style-type: none"> <li>Selected parameter flashes.</li> <li>New value appears.</li> </ol>                    | Chapter 5.4.1                        |
| Soft start/stop                            | <ol style="list-style-type: none"> <li>Press <b>time</b> repeatedly.</li> <li>Press <b>▲</b> or <b>▼</b> to select ramp.</li> </ol>          | ↗: Acceleration ramp 0 (long) ... 9 (short).<br>↘: Deceleration ramp 0 (long) ... 9 (short).                                 | Chapter 6.2 (English, German)        |
| Alarm ON/OFF                               | ▶ Press <b>speed</b> + <b>time</b> simultaneously.   | <i>Alarm on/Alarm off</i>  | Chapter 6.7.2 (English, German)      |
| Programming (during rotor stop only)       | <ol style="list-style-type: none"> <li>Set parameter.</li> <li>Press 2 × <b>prog</b>.</li> <li>Store: Press <b>prog</b> &gt; 2 s.</li> </ol> | <ol style="list-style-type: none"> <li>Parameter.</li> <li><i>P...</i>: first idle program no.</li> <li><i>OK</i></li> </ol> | Chapters 6.4 - 6.6 (English, German) |
| At set rpm (with open centrifuge lid only) | Press <b>start stop</b> > 4 s.   | : on/ : off  | Chapter 6.3 (English, German)        |

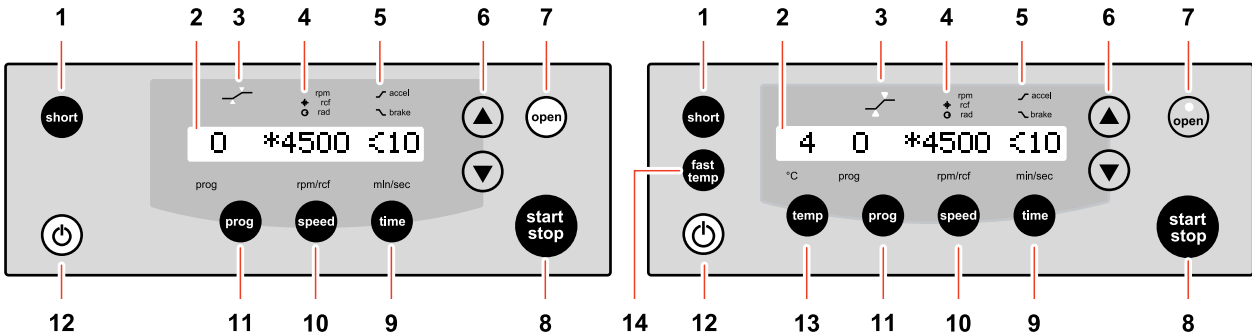

|   |  |
|---|--|
| 1 Short spin centrifugation                                 | 2 Display  |
| 3 Status At set rpm function                                | 4 Indicate speed (rpm), g-force (rcf) * and radius setting $\odot$ . |
| 5 Symbol for acceleration $\swarrow$ and braking $\searrow$ | 6 Set parameters and values  |
| 7 Release centrifuge lid                                    | 8 Start or stop centrifugation                                       |
| 9 Adjust centrifugation time                                | 10 Set centrifugation speed  |
| 11 Select or save program                                   | 12 Standby   |
| 13 Set temperature (only 5804 R/5810 R)                     | 14 Start temperature control run FastTemp (only 5804 R/5810 R)       |



|   |  |
|---|--|
| 1 Program number  | 2 Symbol for g-force (rcf)               |
| 3 g-force (rcf)/rotational speed (rpm)                      | 4 Symbol flashes when rotor is in motion |
| 5 Symbol for acceleration $\swarrow$ and braking $\searrow$ | 6 Centrifugation time                    |
| 7 Temperature (only 5804 R/5810 R)                          |  |

**Rotor code:**

All Eppendorf® rotors are identified using a simple, alphanumeric format that represents the technical specifications in a uniform series of letters and numbers.

|   |   |
|---|---|
| <p>Fixed-angle rotor</p> <p><b>F A — 45 — 30 — 11</b></p> <p>Aerosol-tight version      Number of bores</p> | <p>Swing-bucket rotor</p> <p><b>S — 4 — 72</b></p> <p>Number of buckets</p> |
|---|---|

**Rotor code:**

All Eppendorf® rotors are identified using a simple, alphanumeric format that represents the technical specifications in a uniform series of letters and numbers.

|   |   |
|---|---|
| <p>Fixed-angle rotor</p> <p><b>F A — 45 — 30 — 11</b></p> <p>Aerosol-tight version      Number of bores</p> | <p>Swing-bucket rotor</p> <p><b>A — 4 — 81</b></p> <p>Number of buckets</p> |
|---|---|

## Table of contents

|          |   |           |
|----------|---|-----------|
| <b>1</b> | <b>User instructions</b>                            | <b>9</b>  |
| 1.1      | Using this manual                                   | 9         |
| 1.2      | Danger symbols and danger levels                    | 9         |
| 1.2.1    | Danger symbols                                      | 9         |
| 1.2.2    | Danger levels                                       | 9         |
| 1.3      | Symbols used  | 9         |
| 1.4      | Abbreviations used                                  | 10        |
| <b>2</b> | <b>Product description</b>                          | <b>11</b> |
| 2.1      | Main illustration                                   | 11        |
| 2.2      | Delivery package                                    | 11        |
| 2.3      | Features  | 12        |
| 2.4      | Rotors  | 13        |
| 2.4.1    | Rotor A-4-81 (only 5810/5810 R)                     | 13        |
| 2.4.2    | Rotor A-4-62 and A-4-62-MTP (only 5810/5810 R)      | 18        |
| 2.4.3    | Rotor A-4-44  | 22        |
| 2.4.4    | Rotor A-2-DWP-AT (only 5810/5810 R)                 | 24        |
| 2.4.5    | Rotor A-2-DWP                                       | 26        |
| 2.4.6    | Rotor FA-45-6-30                                    | 28        |
| 2.4.7    | Rotor F-34-6-38                                     | 29        |
| 2.4.8    | Rotors FA-45-30-11 and F-45-30-11                   | 31        |
| 2.4.9    | Rotor F-45-48-PCR                                   | 32        |
| 2.4.10   | Rotor T-60-11                                       | 32        |
| 2.4.11   | Rotor S-4-104 (only 5810/5810 R)                    | 33        |
| 2.4.12   | Rotor S-4-72  | 36        |
| 2.4.13   | Rotor F-35-48-17                                    | 38        |
| 2.4.14   | Rotor FA-45-48-11                                   | 39        |
| 2.4.15   | Rotor FA-45-20-17                                   | 40        |
| <b>3</b> | <b>Safety</b>                                       | <b>41</b> |
| 3.1      | Intended use  | 41        |
| 3.2      | User profile  | 41        |
| 3.3      | Application limits                                  | 41        |
| 3.3.1    | Declaration concerning the ATEX directive (94/9/EC) | 41        |
| 3.3.2    | Maximum service life for accessories                | 41        |
| 3.4      | Information on product liability                    | 42        |
| 3.5      | Warnings for intended use                           | 43        |
| 3.5.1    | Personal injury or damage to the equipment          | 43        |
| 3.5.2    | Incorrect handling of the centrifuge                | 44        |
| 3.5.3    | Incorrect handling of the rotors                    | 45        |
| 3.5.4    | Extreme strain on the centrifuging tubes            | 46        |
| 3.5.5    | Aerosol-tight centrifugation                        | 47        |
| 3.6      | Safety instructions located on the device           | 47        |
| <b>4</b> | <b>Installation</b>                                 | <b>48</b> |
| 4.1      | Selecting the location                              | 48        |
| 4.2      | Preparing installation                              | 48        |
| 4.3      | Installing the instrument                           | 49        |

|          |  |           |
|----------|--|-----------|
| <b>5</b> | <b>Operation</b>   | <b>50</b> |
| 5.1      | Overview of operating controls                                 | 50        |
| 5.2      | Preparing for centrifugation                                   | 51        |
| 5.2.1    | Switching on the centrifuge                                    | 51        |
| 5.2.2    | Inserting the rotor  | 51        |
| 5.2.3    | Automatic rotor detection                                      | 51        |
| 5.2.4    | Loading the rotor  | 52        |
| 5.2.5    | Closing the centrifuge lid                                     | 55        |
| 5.3      | Cooling (only 5804 R/5810 R)                                   | 55        |
| 5.3.1    | Temperature adjustment   | 55        |
| 5.3.2    | Temperature display  | 55        |
| 5.3.3    | Temperature monitoring   | 55        |
| 5.3.4    | FastTemp   | 55        |
| 5.3.5    | Continuous cooling   | 56        |
| 5.4      | Centrifuging   | 57        |
| 5.4.1    | Centrifuging with preset time                                  | 57        |
| 5.4.2    | Centrifuging in continuous operation                           | 58        |
| 5.4.3    | Short spin centrifugation                                      | 58        |
| 5.4.4    | Removing the rotor   | 59        |
| 5.4.5    | Standby mode   | 59        |
| <b>6</b> | <b>Operating controls and function</b>                         | <b>60</b> |
| 6.1      | Setting the radius   | 60        |
| 6.2      | Setting the acceleration and braking times                     | 60        |
| 6.3      | Setting the start of run time (At set rpm)                     | 60        |
| 6.4      | Saving the program   | 61        |
| 6.5      | Loading the program  | 61        |
| 6.6      | Deleting the program   | 61        |
| 6.7      | Special functions  | 62        |
| 6.7.1    | Display operating hours  | 62        |
| 6.7.2    | Switching on/off the warning signal                            | 62        |
| 6.7.3    | Exiting the service functions                                  | 62        |
| 6.7.4    | Controlling the centrifuge via the serial interface (optional) | 62        |
| <b>7</b> | <b>Maintenance</b>   | <b>63</b> |
| 7.1      | Maintenance  | 63        |
| 7.2      | Prepare cleaning/disinfection                                  | 63        |
| 7.3      | Cleaning/disinfection  | 64        |
| 7.3.1    | Cleaning and disinfecting the device                           | 65        |
| 7.3.2    | Cleaning and disinfecting the rotor                            | 65        |
| 7.4      | Additional service instructions for Centrifuge 5804 R/5810 R   | 66        |
| 7.5      | Glass breakage   | 66        |
| 7.6      | Decontamination before shipment                                | 66        |
| <b>8</b> | <b>Troubleshooting</b>   | <b>67</b> |
| 8.1      | Resetting the excess current switch                            | 67        |
| 8.2      | General errors   | 67        |
| 8.3      | Error messages   | 67        |
| 8.4      | Emergency release  | 69        |
| <b>9</b> | <b>Transport, storage and disposal</b>                         | <b>70</b> |
| 9.1      | Transport  | 70        |
| 9.2      | Storage  | 70        |
| 9.3      | Disposal   | 70        |

|           |  |           |
|-----------|--|-----------|
| <b>10</b> | <b>Technical data</b>                          | <b>71</b> |
| 10.1      | Power supply                                   | 71        |
| 10.2      | Ambient conditions                             | 71        |
| 10.3      | Weight/dimensions                              | 71        |
| 10.4      | Application parameters                         | 72        |
| <b>11</b> | <b>Ordering information</b>                    | <b>74</b> |
| 11.1      | Centrifuge 5804/5804 R                         | 74        |
| 11.2      | Centrifuge 5810/5810 R                         | 74        |
| 11.3      | Rotors and accessories                         | 74        |
| 11.3.1    | Rotor A-4-81 (only 5810/5810 R)                | 74        |
| 11.3.2    | Rotor A-4-62 and A-4-62-MTP (only 5810/5810 R) | 76        |
| 11.3.3    | Rotor A-4-44                                   | 77        |
| 11.3.4    | Rotor A-2-DWP-AT (only 5810/5810 R)            | 78        |
| 11.3.5    | Rotor A-2-DWP                                  | 78        |
| 11.3.6    | Rotor FA-45-6-30                               | 79        |
| 11.3.7    | Rotor F-34-6-38                                | 79        |
| 11.3.8    | Rotor FA-45-30-11 and rotor F-45-30-11         | 80        |
| 11.3.9    | Rotor F-45-48-PCR                              | 80        |
| 11.3.10   | Rotor T-60-11                                  | 80        |
| 11.3.11   | Rotor S-4-104                                  | 81        |
| 11.3.12   | Rotor S-4-72                                   | 82        |
| 11.3.13   | Rotor F-35-48-17                               | 82        |
| 11.3.14   | FA-45-48-11 rotor                              | 82        |
| 11.3.15   | Rotor FA-45-20-17                              | 83        |
| 11.3.16   | Miscellaneous                                  | 83        |





## 1 User instructions







### 1.1 Using this manual

- ▶ Read this operating manual completely before using the device for the first time. Please also note the operating instructions for the accessories, if applicable.
- ▶ This operating manual is part of the product. Thus, it must always be easily accessible.
- ▶ Enclose this operating manual when transferring the device to third parties.
- ▶ If this manual is lost, please request another one. You will find the current version on our webpage [www.eppendorf.com/worldwide](http://www.eppendorf.com/worldwide).

### 1.2 Danger symbols and danger levels

The safety instructions in this manual appear with the following danger symbols and danger levels:



#### 1.2.1 Danger symbols

|   |                       |  |                        |
|---|-----------------------|--|------------------------|
|    | <b>Biohazard</b>      |    | <b>Explosion</b>       |
|   | <b>Electric shock</b> |   | <b>Crushing</b>        |
|  | <b>Hazard point</b>   |  | <b>Material damage</b> |

#### 1.2.2 Danger levels

|                |   |
|----------------|---|
| <b>DANGER</b>  | <i>Will</i> lead to severe injuries or death. |
| <b>WARNING</b> | <i>May</i> lead to severe injuries or death.  |
| <b>CAUTION</b> | May lead to light to moderate injuries.       |
| <b>NOTICE</b>  | May lead to material damage.                  |

### 1.3 Symbols used

| Example   | Meaning  |
|---|--|
| ▶   | You are requested to perform an action.          |
| 1.<br>2.  | Perform these actions in the sequence described. |
| •   | List.  |
|  | Press this key to perform the described action.  |
| <i>Text</i>   | Terms from the display of the device.            |
|  | References useful information.                   |

## 1.4 Abbreviations used

|             |  |
|-------------|--|
| <b>MTP</b>  | Micro test plate                                   |
| <b>NN</b>   | Mean sea level (MSL)                               |
| <b>PCR</b>  | Polymerase chain reaction                          |
| <b>PTFE</b> | Polytetrafluorethylene                             |
| <b>RCF</b>  | Relative centrifugal force – $g$ -force in $m/s^2$ |
| <b>rpm</b>  | Revolutions per minute – in rpm                    |
| <b>UV</b>   | Ultraviolet radiation                              |

## 2 Product description

### 2.1 Main illustration



Fig. 1: Depiction of Centrifuge 5810 and Centrifuge 5810 R. The Centrifuge 5804 and Centrifuge 5804 R are similar in design.

|  |  |
|--|--|
| <b>1 Centrifuge lid</b>  | <b>2 Monitoring glass</b><br>Visual control for rotor stop or option for speed check via stroboscope |
| <b>3 Operator panel with display</b><br>(see <i>Overview of operating controls</i> on p. 50) | <b>4 Emergency release</b><br>(see <i>Emergency release</i> on p. 69)                                |
| <b>5 Condensation water tray (only Centrifuge 5804 R/ 5810 R)</b>                            |  |

The depiction of the centrifuge can be found on the front fold-out page (see Fig. 1).

### 2.2 Delivery package

Each delivery package consists of one of the following centrifuges and the accessories listed in the following.

| Quantity | Order no. (international) | Order No. (North America) | Description   |
|----------|---------------------------|---------------------------|---|
| 1        | -                         | -                         | <b>5804/5804 R/5810/5810 R centrifuge</b><br>See chapter <i>Ordering Information</i> for corresponding device version, equipment and order number |
| 1        | 5810 350.018              | 022664166                 | <b>Rotor key</b><br>Standard  |
| 1        | -                         | -                         | <b>Power cable</b><br>see chapter <i>Ordering information</i> for corresponding power cable variants and order numbers                            |

| Quantity | Order no. (international) | Order No. (North America) | Description   |
|----------|---------------------------|---------------------------|---|
| 1        | 5820 900.040              | 5820900040                | <b>Operating manual</b><br>Centrifuge 5804/5804 R/5810/5810 R<br>Languages: EN, DE, FR, ES, IT, PT                  |
| 1        | 5820 900.059              | 5820900059                | <b>Operating manual</b><br>Centrifuge 5804/5804 R/5810/5810 R<br>Languages: DA, EL, FI, NL, SV (230 V devices only) |
| 1        | 5820 901.004              | -                         | <b>Test log book</b><br>(for Germany only)  |

Only 5804 R and 5810 R:

| Quantity | Order no. (international) | Order No. (North America) | Description                        |
|----------|---------------------------|---------------------------|------------------------------------|
| 1        | 5811 001.068              | 022662678                 | <b>Tray for condensation water</b> |

## 2.3 Features

The versatile 5804/5804 R/5810/5810 R centrifuge has a capacity of maximally 4 × 250 mL (5804/5804 R centrifuge) resp. 4 × 750 mL (5810/5810 R centrifuge) and achieves max. 20,800 × g/14,000 rpm. The versatility is reflected in the available rotor options. You can select between 12 (5804/5804 R centrifuge) resp. 16 (5810/5810 R centrifuge) different rotors to centrifuge the following tubes for your various applications:

- Micro test tubes (0.2 to 5.0 mL)
- PCR strips
- Microtainers
- Spin columns
- Cryotubes
- Conical tubes (15/50 mL)
- Bottles (175 to 750 mL)
- Various tubes (3 to 120 mL)
- Microplates
- PCR plates
- Deepwell plates (max. height 29 mm)
- Slides (with CombiSlide adapter)
- Cell culture tubes

Handling the centrifuge is facilitated by:

- Low access height of 29 cm for loading and unloading the rotors
- Automatic rotor detection with rotational speed limit
- Automatic rotor imbalance detection
- Clear digital display

All centrifuges in these series have 35 program spaces for user-defined settings and 10 different acceleration and braking ramps.

Adapter-specific manual radius adjustment guarantees maximum RCF accuracy.

The Centrifuge 5804 R/5810 R has an additional temperature control function for centrifugation between -9°C and 40°C. Use the **FastTemp** function to start a temperature control run without samples to adjust the rotor chamber incl. rotor, buckets and adapters quickly to the set target temperature. Continuous cooling also maintains the temperature in the rotor chamber with the centrifuge lid closed when the centrifuge is not in use.

The built-in condensation drain eliminates water accumulation and prevents corrosion.

## 2.4 Rotors



Eppendorf centrifuges may only be operated with rotors that are intended for use with the corresponding centrifuge.

- ▶ Only use rotors which bear the name of the centrifuge (e.g. 5804 R).











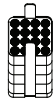



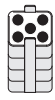

You can operate the 5804/5804 R/5810/5810 R centrifuge with the following rotors. Before use of sample tubes, please note the manufacturer's specifications with regard to centrifugation resistance (max. rcf).

### 2.4.1 Rotor A-4-81 (only 5810/5810 R)

#### Rotor A-4-81 with 500 mL rectangular bucket



|   |                                  |                          |  |
|---|----------------------------------|--------------------------|--|
|   |                                  |                          | Max. <i>g</i> -force: 3,220 × <i>g</i>                   |
| <b>Rotor A-4-81</b><br><br>Swing-bucket rotor with 4 × 500 mL rectangular buckets | <b>Rectangular bucket 500 mL</b> | <b>Aerosol-tight cap</b> | Max. speed: 4,000 rpm                                    |
|   |                                  |                          | Max. load per bucket 780 g (adapter, tube and contents): |



| Vessel | Vessel<br><br>Capacity<br><br>Vessels per adapter/rotor | Adapters<br><br>Order no. (international) | Adapter bottom shape<br><br>Tube diameter<br><br>Max. tube length with/without aerosol-tight bucket cap | Max. <i>g</i> -force<br><br>Max. speed<br><br>Centrifugation radius |
|--------|---|---|---|---|
|        | Vessel<br>1.5/2 mL<br>20/80                             | <br>5810 745.004                          | flat<br>Ø 11 mm<br>43 mm/43 mm  | 2,950 × <i>g</i><br>4,000 rpm<br>16.5 cm                            |
|        | Blood collection tube<br>1.2 to 5 mL<br>20/80           | <br>5810 746.000                          | flat<br>Ø 11 mm<br>108 mm/108 mm  | 3,000 × <i>g</i><br>4,000 rpm<br>16.8 cm                            |
|        | Vessel<br>2.6 to 5 mL<br>25/100                         | <br>5810 720.001                          | flat<br>Ø 13 mm<br>107 mm/108 mm  | 3,000 × <i>g</i><br>4,000 rpm<br>16.8 cm                            |
|        | Vessel<br>2.6 to 7 mL<br>18/72                          | <br>5810 747.007                          | flat<br>Ø 13 mm<br>108 mm/108 mm  | 3,000 × <i>g</i><br>4,000 rpm<br>16.8 cm                            |

| Vessel  | Vessel<br>Capacity<br><br>Vessels per<br>adapter/rotor | Adapters<br><br>Order no.<br>(international)   | Adapter bottom<br>shape<br><br>Tube diameter<br><br>Max. tube length<br>with/without<br>aerosol-tight<br>bucket cap | Max. <i>g</i> -force<br><br>Max. speed<br><br>Centrifugation radius |
|---|--|--|---|---|
|    | Blood collection tube<br>3 to 15 mL<br>16/64           | <br>5810 748.003  | flat<br>Ø 16 mm<br>108 mm/108 mm  | 3,000 × <i>g</i><br>4,000 rpm<br>16.8 cm                            |
|    | Vessel<br>7 to 17 mL<br>16/64                          | <br>5810 721.008  | flat<br>Ø 17.5 mm<br>118 mm/118 mm  | 3,000 × <i>g</i><br>4,000 rpm<br>16.8 cm                            |
|    | Conical tube<br>15 mL<br>12/48                         | <br>5810 722.004  | conical<br>Ø 17.5 mm<br>119 mm/121 mm   | 3,100 × <i>g</i><br>4,000 rpm<br>17.3 cm                            |
|  | Conical tube<br>50 mL<br>5/20                          | <br>5810 723.000  | conical<br>Ø 31 mm<br>116 mm/122 mm   | 3,100 × <i>g</i><br>4,000 rpm<br>17.3 cm                            |
|  | Centriprep<br>50 mL<br>5/20                            | <br>5810 739.004  | flat<br>Ø 31 mm<br>(Do not use the<br>aerosol-tight cap.)/<br>121 mm  | 3,100 × <i>g</i><br>4,000 rpm<br>17.3 cm                            |
|  | Conical tube, skirted<br>50 mL<br>5/20                 | <br>5810 739.004<br><br>5804 737.008 | flat<br>Ø 31 mm<br>(Do not use the<br>aerosol-tight cap.)/<br>119 mm  | 3,100 × <i>g</i><br>4,000 rpm<br>17.3 cm                            |
|  | Bottles<br>180 to 250 mL<br>1/4                        | <br>5825 722.000  | flat<br>Ø 62 mm<br>(Do not use the<br>aerosol-tight cap.)/<br>133 mm  | 3,100 × <i>g</i><br>4,000 rpm<br>17.3 cm                            |
|  | Wide-neck bottle<br>400 mL<br>1/4                      | <br>5810 728.002  | flat<br>Ø 81 mm<br>(Do not use the<br>aerosol-tight cap.)/<br>133 mm  | 3,220 × <i>g</i><br>4,000 rpm<br>18.0 cm                            |

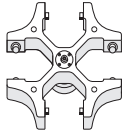
| Vessel  | Vessel<br>Capacity<br><br>Vessels per adapter/rotor    | Adapters<br><br>Order no. (international) | Adapter bottom shape<br><br>Tube diameter<br><br>Max. tube length with/without aerosol-tight bucket cap | Max. <i>g</i> -force<br><br>Max. speed<br><br>Centrifugation radius |
|---|--|---|---|---|
|  | Wide-neck bottle, rectangular<br><br>500 mL<br><br>-/4 | -   | flat<br><br>83 mm<br><br>134 mm/134 mm  | 3,220 × <i>g</i><br><br>4,000 rpm<br><br>18.0 cm                    |





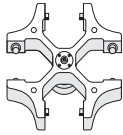
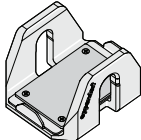

### Rotor A-4-81 with conical tubes

|   |   |   |
|---|---|---|
|  |  | Max. <i>g</i> -force: 3,220 × <i>g</i>                      |
| <b>Rotor A-4-81</b><br><br>Swing-bucket rotor with 4 buckets for conical tubes    | <b>Bucket for 7 × 50 mL conical tubes</b>   | Max. speed: 4,000 rpm                                       |
|   |   | Max. load per bucket (adapter, tube and contents): 7 × 75 g |

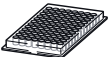
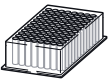
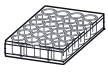

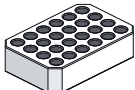
| Vessel  | Vessel<br>Capacity<br><br>Vessels per adapter/rotor | Adapters<br><br>Order no. (international)   | Bottom shape<br><br>Tube diameter<br><br>Max. tube length | Max. <i>g</i> -force<br><br>Max. speed<br><br>Centrifugation radius |
|---|---|---|---|---|
|  | Conical tube<br><br>15 mL<br><br>7/28               | <br><br>5820 718.005 | conical<br>Ø 17.5 mm<br><br>120 mm                        | 3,184 × <i>g</i><br><br>4,000 rpm<br><br>17.8 cm                    |
|  | Conical tube<br><br>50 mL<br><br>7/28               | -   | conical<br>Ø 30 mm<br><br>117 mm                          | 3,220 × <i>g</i><br><br>4,000 rpm<br><br>18.0 cm                    |

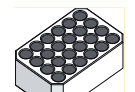
### Rotor A-4-81 with MTP/Flex carrier

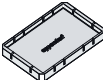
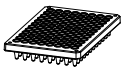
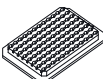
|   |   |   |
|---|---|---|
|  |  | Max. <i>g</i> -force: 2,900 × <i>g</i>  |
| <b>Rotor A-4-81</b><br>Swing-bucket rotor with 4 MTP/Flex carriers                | <b>MTP/Flex buckets</b>   | Max. speed: 4,000 rpm<br>Max. load per bucket (adapter, plate and contents): 380 <i>g</i> |

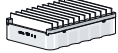

| Vessel  | Plate<br>Capacity<br><br>Plates, rack or glass slides per adapter/rotor | Adapters<br>Order no. (international)   | Bottom shape<br>Tube diameter<br><br>Max. loading height | Max. <i>g</i> -force<br>Max. speed<br><br>Centrifugation radius |
|---|---|---|--|---|
|   | Micro test plate<br>96/384 wells<br>4/16                                | -   | flat<br>-<br>60 mm                                       | 2,900 × <i>g</i><br>4,000 rpm<br>16.3 cm                        |
|  | Deepwell plate<br>96 wells<br>1/4                                       | -   | flat<br>-<br>60 mm                                       | 2,900 × <i>g</i><br>4,000 rpm<br>16.3 cm                        |
|  | Cell culture plate<br><br>2/8   | -   | flat<br>-<br>60 mm                                       | 2,900 × <i>g</i><br>4,000 rpm<br>16.3 cm                        |
|  | Kit<br><br>1/4  | -   | flat<br>-<br>60 mm                                       | 2,900 × <i>g</i><br>4,000 rpm<br>16.3 cm                        |
|  | Tube in IsoRack<br>24 × 0.5 mL<br>1/4                                   | <br>5825 708.008 | flat<br>Ø 6 mm<br>60 mm                                  | 2,700 × <i>g</i><br>4,000 rpm<br>15.0 cm                        |
|  | Tube in IsoRack<br>24 × 1.5/2 mL<br>1/4                                 | <br>5825 709.004 | flat<br>Ø 11 mm<br>60 mm                                 | 2,600 × <i>g</i><br>4,000 rpm<br>14.6 cm                        |
|  | 384-well PCR plate<br><br>1/4   | <br>5825 713.001 | flat<br>-<br>60 mm                                       | 2,700 × <i>g</i><br>4,000 rpm<br>15.8 cm                        |
|  | 96-well PCR plate<br><br>1/4  | <br>5825 711.009 | flat<br>-<br>60 mm                                       | 2,600 × <i>g</i><br>4,000 rpm<br>16.1 cm                        |

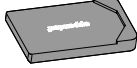





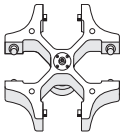
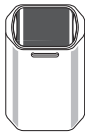

























| Vessel  | Plate<br>Capacity<br><br>Plates, rack or<br>glass slides per<br>adapter/rotor  | Adapters<br><br>Order no.<br>(international)  | Bottom shape<br><br>Tube diameter<br><br>Max. loading height | Max. <i>g</i> -force<br><br>Max. speed<br><br>Centrifugation radius                      |
|---|--|---|--|--|
| Slides  | CombiSlide<br>12 slides<br>12/48   | <br>5825 706.005 | flat<br>-<br>60 mm   | 1,000 × <i>g</i><br>2,372 rpm<br>15.9 cm   |
|  | Cell culture bottle<br>with/without filter<br><br>75 cm <sup>2</sup> :<br>Sarstedt<br>83.1811.002/<br>83.1811<br><br>25 cm <sup>2</sup> :<br>Sarstedt<br>83.1810.002/<br>83.1810<br><br>Greiner Bio-One<br>690175/690160<br>TPP 90026/90025<br>IWAKI 3102-025<br><br>1/4 | <br>5825 719.000 | flat<br>-<br><br><br><br><br><br><br><br>60 mm               | 1,000 × <i>g</i><br><br><br><br><br><br><br><br>2,501 rpm<br><br><br><br><br><br>14.3 cm |



## 2.4.2 Rotor A-4-62 and A-4-62-MTP (only 5810/5810 R)

### Rotor A-4-62 with 250 mL rectangular bucket

|   |   |   |  |
|---|---|---|--|
|  |  |  | Max. <i>g</i> -force: 3,220 × <i>g</i>                   |
| <b>Rotor A-4-62</b><br><br>Swing-bucket rotor with 4 × 250 mL rectangular buckets | <b>Rectangular bucket 250 mL</b>  | <b>Aerosol-tight cap</b>  | Max. speed: 4,000 rpm                                    |
|   |   |   | Max. load per bucket 620 g (adapter, tube and contents): |



| Vessel  | Vessel<br>Capacity<br><br>Vessels per adapter/rotor | Adapters<br><br>Order no. (international)   | Adapter bottom shape<br><br>Tube diameter<br><br>Max. tube length with/without aerosol-tight bucket cap | Max. <i>g</i> -force<br><br>Max. speed<br><br>Centrifugation radius |
|---|---|---|---|---|
|  | Vessel<br>1.5/2 mL<br>16/64                         | <br>5810 751.004 | flat<br>Ø 11 mm<br>43 mm/43 mm  | 3,000 × <i>g</i><br>4,000 rpm<br>17.1 cm                            |
|  | Vessels<br>1.2 to 5 mL<br>25/100                    | <br>5810 750.008 | flat<br>Ø 11 mm<br>115 mm/123 mm  | 3,050 × <i>g</i><br>4,000 rpm<br>17.3 cm                            |
|  | Vessels<br>2.6 to 7 mL<br>15/60                     | <br>5810 752.000 | flat<br>Ø 13 mm<br>118 mm/121 mm  | 3,050 × <i>g</i><br>4,000 rpm<br>17.3 cm                            |
|  | Vessels<br>3 to 15 mL<br>12/48                      | <br>5810 753.007 | flat<br>Ø 16 mm<br>116 mm/121 mm  | 3,050 × <i>g</i><br>4,000 rpm<br>17.3 cm                            |
|  | Vessels<br>7 to 17 mL<br>12/48                      | <br>5810 754.003 | flat<br>Ø 17.5 mm<br>114 mm/118 mm  | 3,050 × <i>g</i><br>4,000 rpm<br>17.3 cm                            |
|  | Conical tube<br>15 mL<br>9/36                       | <br>5810 755.000 | conical<br>Ø 17.5 mm<br>121 mm/127 mm   | 3,150 × <i>g</i><br>4,000 rpm<br>17.8 cm                            |

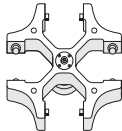
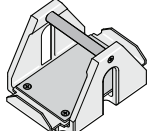

| Vessel  | Vessel<br>Capacity<br><br>Vessels per<br>adapter/rotor | Adapters<br><br>Order no.<br>(international)   | Adapter bottom<br>shape<br><br>Tube diameter<br><br>Max. tube length<br>with/without<br>aerosol-tight<br>bucket cap | Max. <i>g</i> -force<br><br>Max. speed<br><br>Centrifugation radius |
|---|--|--|---|---|
|    | Vessel<br>7 to 18 mL<br>8/32                           | <br>5810 756.006  | flat<br>Ø 20 mm<br>119 mm/126 mm  | 3,050 × <i>g</i><br>4,000 rpm<br>17.3 cm                            |
|    | Vessel<br>18 to 30 mL<br>4/16                          | <br>5810 757.002  | flat<br>Ø 26 mm<br>116 mm/119 mm  | 3,050 × <i>g</i><br>4,000 rpm<br>17.3 cm                            |
|    | Conical tube<br>50 mL<br>3/12                          | <br>5810 758.009  | conical<br>Ø 31 mm<br>116 mm/122 mm   | 3,150 × <i>g</i><br>4,000 rpm<br>17.8 cm                            |
|  | Conical tube<br>50 mL<br>4/16                          | <br>5810 763.002<br><br>5804 728.009 | conical<br>Ø 31 mm<br>(Do not use the<br>aerosol-tight cap.)/<br>122 mm   | 3,050 × <i>g</i><br>4,000 rpm<br>17.3 cm                            |
|  | Vessel<br>30 to 50 mL<br>4/16                          | <br>5810 759.005  | flat<br>Ø 31 mm<br>(Do not use the<br>aerosol-tight cap.)/<br>119 mm  | 3,050 × <i>g</i><br>4,000 rpm<br>17.3 cm                            |
|  | Conical tube, skirted<br>50 mL<br>4/16                 | <br>5810 759.005<br><br>5804 737.008 | flat<br>Ø 31 mm<br>(Do not use the<br>aerosol-tight cap.)/<br>119 mm  | 3,050 × <i>g</i><br>4,000 rpm<br>17.3 cm                            |
|  | Vessel<br>50 to 75 mL<br>2/8                           | <br>5810 760.003  | flat<br>Ø 35 mm<br>118/122 mm   | 3,050 × <i>g</i><br>4,000 rpm<br>17.3 cm                            |
|  | Vessel<br>80 to 120 mL<br>1/4                          | <br>5810 761.000  | flat<br>Ø 45 mm<br>125/138 mm   | 3,050 × <i>g</i><br>4,000 rpm<br>17.3 cm                            |

| Vessel  | Vessel<br><br>Capacity<br><br>Vessels per adapter/rotor | Adapters<br><br>Order no.<br>(international)  | Adapter bottom shape<br><br>Tube diameter<br><br>Max. tube length with/without aerosol-tight bucket cap | Max. <i>g</i> -force<br><br>Max. speed<br><br>Centrifugation radius |
|---|---|---|---|---|
|  | Bottles<br>180 to 250 mL<br>1/4                         | <br>5810 770.009 | flat<br>Ø 62 mm<br>127/136 mm   | 3,220 × <i>g</i><br>4,000 rpm<br>18.0 cm                            |

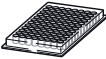
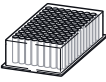
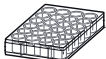

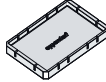
### Rotor A-4-62 with MTP carrier

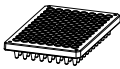
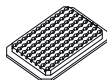
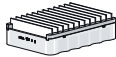

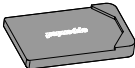



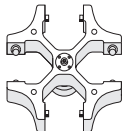
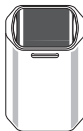





|   |   |  |                  |
|---|---|--|------------------|
|  |  | Max. <i>g</i> -force:                              | 2,750 × <i>g</i> |
| <b>Rotor A-4-62</b><br>Swing-bucket rotor with 4 MTP buckets                      | <b>MTP buckets</b>  | Max. speed:  | 4,000 rpm        |
|   |   | Max. load per bucket (adapter, plate and contents) | 380 g            |



















| Plate   | Plate<br><br>Capacity<br><br>Plates or glass slides per adapter/rotor | Adapters<br><br>Order no.<br>(international)  | Bottom shape<br><br>Max. loading height | Max. <i>g</i> -force<br><br>Max. speed<br><br>Centrifugation radius |
|---|---|---|---|---|
|  | Micro test plate<br>96/384 wells<br>4/16                              |   | flat<br>53 mm                           | 2,750 × <i>g</i><br>4,000 rpm<br>15.4 cm                            |
|  | Deepwell plate<br>96/384 wells<br>1/4                                 |   | flat<br>53 mm                           | 2,750 × <i>g</i><br>4,000 rpm<br>15.4 cm                            |
|  | Cell culture plate<br><br>2/8   |   | flat<br>53 mm                           | 2,750 × <i>g</i><br>4,000 rpm<br>15.4 cm                            |
|  | 384-well PCR plate<br><br>1/4   | <br>5825 713.001 | flat<br>53 mm                           | 2,700 × <i>g</i><br>4,000 rpm<br>14.9 cm                            |





| Plate   | Plate Capacity<br><br>Plates or glass slides per adapter/rotor  | Adapters<br><br>Order no. (international)   | Bottom shape<br><br>Max. loading height           | Max. <i>g</i> -force<br><br>Max. speed<br><br>Centrifugation radius          |
|---|---|---|---|--|
|  | 96-well PCR plate<br><br>1/4  | <br>5825 711.009 | flat<br><br>53 mm                                 | 2,600 × <i>g</i><br>4,000 rpm<br>15.2 cm                                     |
| Slides  | CombiSlide<br>12 slides<br>12/48  | <br>5825 706.005 | flat<br><br>53 mm                                 | 1,000 × <i>g</i><br>2,442 rpm<br>15.0 cm                                     |
|  | Cell culture bottle<br><br>75 cm <sup>2</sup> :<br>Sarstedt<br>83.1811.002/<br>83.1811<br><br>25 cm <sup>2</sup> :<br>Sarstedt<br>83.1810.002/<br>83.1810<br><br>Greiner Bio-One<br>690175/690160<br>TPP 90026/90025<br>IWAKI 3102-025<br><br>1/4 | <br>5825 719.000 | flat<br><br><br><br><br><br><br><br><br><br>60 mm | 1,000 × <i>g</i><br>2,584 rpm<br><br><br><br><br><br><br><br><br><br>13.4 cm |

### 2.4.3 Rotor A-4-44

|   |   |   |  |
|---|---|---|--|
|  |  |  | Max. <i>g</i> -force: 4,400 × <i>g</i>                   |
| <b>Rotor A-4-44</b><br><br>Swing-bucket rotor with 4 × 100 mL rectangular buckets | <b>Rectangular bucket 100 mL</b>  | <b>Aerosol-tight cap</b>  | Max. speed: 5,000 rpm                                    |
|   |   |   | Max. load per bucket (adapter, tube and contents): 310 g |

| Vessel  | Vessel<br>Capacity<br><br>Vessels per adapter/rotor | Adapters<br><br>Order no. (international)   | Adapter bottom shape<br><br>Tube diameter<br><br>Max. tube length with/without aerosol-tight bucket cap | Max. <i>g</i> -force<br><br>Max. speed<br><br>Centrifugation radius |
|---|---|---|---|---|
|  | Vessel<br>1.5/2 mL<br>12/48                         | <br>5804 751.000 | flat<br>Ø 11 mm<br>43 mm/43 mm  | 4,100 × <i>g</i><br>5,000 rpm<br>14.8 cm                            |
|  | Vessels<br>1.2 to 5 mL<br>14/56                     | <br>5804 750.004 | flat<br>Ø 11 mm<br>102 mm/105 mm  | 4,200 × <i>g</i><br>5,000 rpm<br>15.0 cm                            |
|  | Vessels<br>2.6 to 7 mL<br>9/36                      | <br>5804 752.007 | flat<br>Ø 13 mm<br>106 mm/108 mm  | 4,200 × <i>g</i><br>5,000 rpm<br>15.0 cm                            |
|  | Vessels<br>3 to 15 mL<br>7/28                       | <br>5804 753.003 | flat<br>Ø 16 mm<br>106 mm/108 mm  | 4,200 × <i>g</i><br>5,000 rpm<br>15.0 cm                            |
|  | Vessels<br>7 to 17 mL<br>6/24                       | <br>5804 754.000 | flat<br>Ø 17.5 mm<br>106 mm/110 mm  | 4,200 × <i>g</i><br>5,000 rpm<br>15.0 cm                            |
|  | Conical tube<br>15 mL<br>4/16                       | <br>5804 755.006 | conical<br>Ø 17.5 mm<br>(Do not use the aerosol-tight cap.)/<br>121 mm                                  | 4,300 × <i>g</i><br>5,000 rpm<br>15.5 cm                            |

| Vessel  | Vessel<br><br>Capacity<br><br>Vessels per<br>adapter/rotor | Adapters<br><br>Order no.<br>(international)   | Adapter bottom<br>shape<br><br>Tube diameter<br><br>Max. tube length<br>with/without<br>aerosol-tight<br>bucket cap | Max. <i>g</i> -force<br><br>Max. speed<br><br>Centrifugation radius |
|---|--|--|---|---|
|    | Conical tube<br>15 mL<br>2/8                               | <br>5804 717.007  | conical<br>Ø 17.5 mm<br>121 mm/121 mm   | 4,400 × <i>g</i><br>5,000 rpm<br>15.7 cm                            |
|    | Vessel<br>7 to 18 mL<br>4/16                               | <br>5804 756.002  | flat<br>Ø 20 mm<br>104 mm/107 mm  | 4,200 × <i>g</i><br>5,000 rpm<br>15.0 cm                            |
|    | Vessel<br>18 to 30 mL<br>2/8                               | <br>5804 757.009  | flat<br>Ø 26 mm<br>100 mm/110 mm  | 4,200 × <i>g</i><br>5,000 rpm<br>15.0 cm                            |
|  | Conical tube<br>50 mL<br>1/4                               | <br>5804 758.005  | conical<br>Ø 31 mm<br>(Do not use the<br>aerosol-tight cap.)/<br>122 mm   | 4,300 × <i>g</i><br>5,000 rpm<br>15.5 cm                            |
|  | Conical tube<br>50 mL<br>1/4                               | <br>5804 718.003  | conical<br>Ø 31 mm<br>119 mm/122 mm   | 4,400 × <i>g</i><br>5,000 rpm<br>15.7 cm                            |
|  | Conical tube<br>50 mL<br>-/8                               | <br>5804 706.005<br><br>Max. load 144 g<br>(insert, tubes and<br>contents) | flat with conical<br>insert<br>-<br>(Do not use the<br>aerosol-tight cap.)/<br>120 mm                               | 4,500 × <i>g</i><br>5,000 rpm<br>16.1 cm                            |
|  | Vessel<br>30 to 50 mL<br>1/4                               | <br>5804 759.001  | flat<br>Ø 31 mm<br>108 mm/122 mm  | 4,200 × <i>g</i><br>5,000 rpm<br>15.0 cm                            |
|  | Conical tube, skirted<br>50 mL<br>1/4                      | <br>5804 759.001<br><br>5804 737.008                                       | flat<br>Ø 31 mm<br>108 mm/122 mm  | 4,200 × <i>g</i><br>5,000 rpm<br>15.0 cm                            |





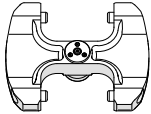
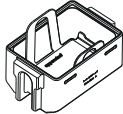
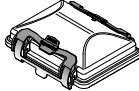

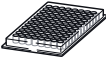
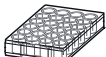
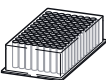

| Vessel  | Vessel<br><br>Capacity<br><br>Vessels per adapter/rotor | Adapters<br><br>Order no.<br>(international)  | Adapter bottom shape<br><br>Tube diameter<br><br>Max. tube length with/without aerosol-tight bucket cap | Max. <i>g</i> -force<br><br>Max. speed<br><br>Centrifugation radius |
|---|---|---|---|---|
|  | Vessel<br>50 to 75 mL<br>1/4                            | <br>5804 760.000 | flat<br>Ø 35 mm<br>108 mm/119 mm  | 4,200 × <i>g</i><br>5,000 rpm<br>15.0 cm                            |
|  | Vessel<br>80 to 100 mL<br>1/4                           | <br>5804 761.006 | flat<br>Ø 45 mm<br>100 mm/114 mm  | 4,200 × <i>g</i><br>5,000 rpm<br>15.0 cm                            |

### 2.4.4 Rotor A-2-DWP-AT (only 5810/5810 R)

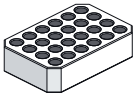
|  |  |  |   |
|--|--|--|---|
|  |  |  | Max. <i>g</i> -force: 3,486 × <i>g</i>                    |
| <b>Rotor A-2-DWP</b><br><br>Swing-bucket rotor with 2 aerosol-tight buckets        | <b>Bucket</b><br><br>(always use with plate carrier)                               | <b>Aerosol-tight cap</b>   | Max. speed: 4,500 rpm                                     |
|  |  |  | Max. load per bucket 500 g (adapter, plate and contents): |

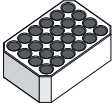
| Plate   | Plate<br><br>Capacity<br><br>Plate/ slide per adapter/rotor | Adapters<br><br>Order no.<br>(international) | Adapter bottom shape<br><br>Max. loading height | Max. <i>g</i> -force<br><br>Max. speed<br><br>Centrifugation radius |
|---|---|--|---|---|
|  | Micro test plate<br>96/384 wells<br>4/16                    | -  | 60 mm   | 3,486 × <i>g</i><br>4,500 rpm<br>154 mm                             |
|  | Cell culture plate<br><br>2/8                               | -  | 60 mm   | 3,486 × <i>g</i><br>4,500 rpm<br>154 mm                             |
|  | Deepwell plate<br>96 mL<br>1/4                              |  | flat<br>67 mm                                   | 3,486 × <i>g</i><br>4,500 rpm<br>154 mm                             |

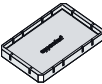
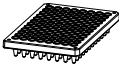
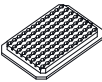





| Plate   | Plate<br>Capacity<br>Plate/ slide per<br>adapter/rotor    | Adapters<br><br>Order no.<br>(international)  | Adapter bottom<br>shape<br><br>Max. loading height | Max. <i>g</i> -force<br><br>Max. speed<br><br>Centrifugation radius |
|---|---|---|--|---|
|    | Kit<br><br>1/4  | -   | 60 mm  | 3,486 × <i>g</i><br>4,500 rpm<br>154 mm                             |
|    | IsoRack<br>24 × 0.5 mL micro<br>test tubes<br><br>1/4     |                    | open<br>Ø 6 mm<br><br>60 mm                        | 2,500 × <i>g</i><br>3,900 rpm<br>147 mm                             |
|    | IsoRack<br>24 × 1,5/2,0 mL<br>micro test tubes<br><br>1/4 |                    | open<br>Ø 11 mm<br><br>60 mm                       | 2,432 × <i>g</i><br>3.900 <i>g</i><br>143 mm                        |
|  | PCR plate<br>384 wells<br><br>1/4                         | <br>5825 713.001 | 60 mm  | 3,486 × <i>g</i><br>4,500 rpm<br>149 mm                             |
|  | PCR plate<br>96 wells<br><br>1/4                          | <br>5825 711.009 | 60 mm  | 3,486 × <i>g</i><br>4,500 rpm<br>154 mm                             |
| Slides  | CombiSlide<br>8 slides<br><br>8/16                        | <br>5825 706.005 | flat<br><br>60 mm                                  | 100 × <i>g</i><br>772 rpm<br>150 mm                                 |

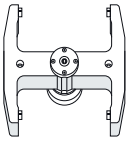
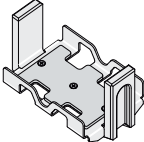

## 2.4.5 Rotor A-2-DWP

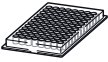
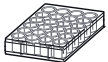
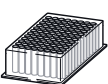
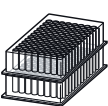

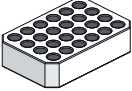
Check the load if using two fully loaded DWP plates.

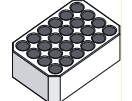
|   |   |  |
|---|---|--|
|  |  | Max. <i>g</i> -force: $2,250 \times g$                       |
| <b>Rotor A-2-DWP</b><br><br>Swing-bucket rotor with 2 Deepwell plate carriers     | <b>Deepwell plate carrier</b>   | Max. speed: 3,700 rpm  |
|   |   | Max. load per bucket 380 g<br>(adapter, plate and contents): |

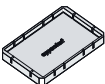
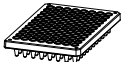
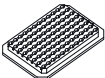







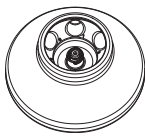







|   | Plate                                   | Plate<br>Capacity<br><br>Plates/slides per adapter/rotor  | Adapters<br><br>Order no.<br>(international) | Adapter bottom shape<br><br>Max. loading height | Max. <i>g</i> -force<br><br>Max. speed<br><br>Centrifugation radius |
|---|---|---|--|---|---|
|  | Micro test plate<br>96/384 wells<br>4/8 | SBS adapter*<br>5825 718.003  | flat<br><br>89 mm                            | $2,250 \times g$<br>4,000 rpm<br>14.7 cm        |   |
|  | Cell culture plate<br><br>4/8           | SBS adapter*<br>5825 718.003  | flat<br><br>89 mm                            | $2,250 \times g$<br>4,000 rpm<br>14.7 cm        |   |
|  | Deepwell plate<br>96 wells<br>2/4       | SBS adapter*<br>5825 718.003  | flat<br><br>89 mm                            | $2,250 \times g$<br>4,000 rpm<br>14.7 cm        |   |
|  | Kit<br><br>1/2                          | SBS adapter*<br>5825 718.003  | flat<br><br>89 mm                            | $2,250 \times g$<br>4,000 rpm<br>14.7 cm        |   |
|  | Tube in IsoRack<br>24 × 0.5 mL<br>1/2   | <br>5825 708.008 | flat<br>Ø 6 mm<br>89 mm                      | $2,050 \times g$<br>3,700 rpm<br>13.8 cm        |   |
|  | Tube in IsoRack<br>24 × 1.5/2 mL<br>1/2 | <br>5825 709.004 | flat<br>Ø 11 mm<br>89 mm                     | $1,990 \times g$<br>3,700 rpm<br>13.3 cm        |   |





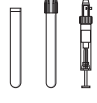

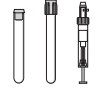
| Plate   | Plate<br><br>Capacity<br><br>Plates/slides per<br>adapter/rotor | Adapters<br><br>Order no.<br>(international)  | Adapter bottom<br>shape<br><br>Max. loading height | Max. <i>g</i> -force<br><br>Max. speed<br><br>Centrifugation radius |
|---|---|---|--|---|
|  | 384-well PCR plate<br><br>1/2                                   | <br><br>5825 713.001 | flat<br><br>89 mm                                  | 2,170 × <i>g</i><br>3,700 rpm<br>14.2 cm                            |
|  | 96-well PCR plate<br><br>1/2                                    | <br><br>5825 711.009 | flat<br><br>89 mm                                  | 2,220 × <i>g</i><br>3,700 rpm<br>14.5 cm                            |
| Slides  | CombiSlide<br>8 slides<br>8/16                                  | <br><br>5825 706.005 | flat<br><br>60 mm                                  | 100 × <i>g</i><br>791 rpm<br>14.3 cm                                |

\*) Optional. Secures the plate against slipping .

## 2.4.6 Rotor FA-45-6-30







|   |  |  |
|---|--|--|
|  | <b>Rotor FA-45-6-30</b><br>Fixed-angle rotor for 6 conical tubes | Max. <i>g</i> -force: 16,639 × <i>g</i> (5810 R: 20,133 × <i>g</i> ) |
|   |  | Max. speed: 11,000 rpm (5810 R: 12,100 rpm)                          |
|   |  | Max. load (adapter, tube and contents): 6 × 75 g                     |

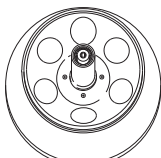













|    | Vessel                       | Adapters  | Adapter bottom shape            | Max. <i>g</i> -force at 11,000 rpm (5804/5804 R/5810) |
|---|------------------------------|---|---------------------------------|---|
|   | Capacity                     | Order no. (international)   | Tube diameter                   | Max. <i>g</i> -force at 12,100 rpm (5810 R)           |
|   | Vessels per adapter/rotor    |   | Max. tube length with rotor lid | Centrifugation radius                                 |
|    | Conical tube<br>15 mL<br>1/6 | <br>5820 717.009   | conical<br>Ø 17 mm<br>125 mm    | 16,233 × <i>g</i><br>19,642 × <i>g</i><br>12.0 cm     |
|   | Conical tube<br>50 mL<br>1/6 | -   | conical<br>Ø 30 mm<br>127 mm    | 16,639 × <i>g</i><br>20,133 × <i>g</i><br>12.3 cm     |
|  | Oak Ridge<br>16 mL<br>1/6    | <br>5820 720.000 | Round<br>Ø 18.1 mm<br>107 mm    | 16,233 × <i>g</i><br>19,642 × <i>g</i><br>12.0 cm     |
|  | Oak Ridge<br>30 mL<br>1/6    | <br>5820 721.006 | Round<br>Ø 25.7 mm<br>104 mm    | 14,204 × <i>g</i><br>17,187 × <i>g</i><br>10.5 cm     |
|  | Oak Ridge<br>35 mL<br>1/6    | <br>5820 722.002 | conical<br>Ø 28.7 mm<br>113 mm  | 15,151 × <i>g</i><br>18,333 × <i>g</i><br>11.2 cm     |
|  | Vessel<br>5 mL<br>1/6        | <br>5820 730.005 | conical<br>Ø 17 mm<br>-         | 16,369 × <i>g</i><br>19,806 × <i>g</i><br>12.1 cm     |
|  | Vessel<br>2,6 to 5 mL<br>1/6 | <br>5820 726.008 | Round<br>Ø 13,5 mm<br>-         | 16,233 × <i>g</i><br>19,246 × <i>g</i><br>12.0 cm     |
|  | Vessel<br>4 to 8 mL<br>1/6   | <br>5820 725.001 | Round<br>Ø 13,5 mm<br>119 mm    | 16,233 × <i>g</i><br>19,246 × <i>g</i><br>12.0 cm     |

| Vessel  | Vessel<br>Capacity<br>Vessels per<br>adapter/rotor | Adapters<br>Order no.<br>(international)  | Adapter bottom<br>shape<br>Tube diameter<br>Max. tube length<br>with rotor lid | Max. <i>g</i> -force at 11,000 rpm<br>(5804/5804 R/5810)<br>Max. <i>g</i> -force at 12,100 rpm<br>(5810 R)<br>Centrifugation radius |
|---|--|---|--|---|
|  | Vessel<br>5.5 mL – 10 mL<br>1/6                    | <br>5820 728.000 | Round<br>Ø 16 mm<br>-  | 16,233 × <i>g</i><br>19,246 × <i>g</i><br>12.0 cm   |
|  | Vessel<br>7.5 to 12 mL<br>1/6                      | <br>5820 727.004 | Round<br>Ø 16.4 mm<br>119 mm   | 16,233 × <i>g</i><br>19,246 × <i>g</i><br>12.0 cm   |
|  | Vessel<br>9 mL<br>1/6                              | <br>5820 729.007 | Round<br>Ø 16.4 mm<br>112 mm   | 16,233 × <i>g</i><br>19,246 × <i>g</i><br>12.0 cm   |

### 2.4.7 Rotor F-34-6-38

|   |  |  |
|---|--|--|
|  | <b>Rotor F-34-6-38</b><br>Fixed-angle rotor for<br>6 x 85 mL tubes | Max. <i>g</i> -force: 15,557 × <i>g</i> (5810 R: 18,514 × <i>g</i> ) |
|   |  | Max. speed: 11,000 rpm (5810 R: 12,000 rpm)                          |
|   |  | Max. load (adapter,<br>tube and contents): 6 × 125 g                 |

| Vessel  | Vessel<br>Capacity<br>Vessels per<br>adapter/rotor | Adapters<br>Order no.<br>(international)  | Adapter bottom<br>shape<br>Tube diameter<br>Max. tube length<br>with rotor lid | Max. <i>g</i> -force at 11,000 rpm<br>(5804/5804 R/5810)<br>Max. <i>g</i> -force at 12,100 rpm<br>(5810 R)<br>Centrifugation radius |
|---|--|---|--|---|
|  | Vessel<br>1.5/2 mL<br>4/24                         | <br>5804 770.005 | Round<br>Ø 11 mm<br>43 mm  | 15,300 × <i>g</i><br>18,200 × <i>g</i><br>11.3 cm   |
|  | Vessel<br>5 mL<br>1/6                              | <br>5804 777.000 | conical<br>Ø 17 mm<br>-  | 14,150 × <i>g</i><br>16,842 × <i>g</i><br>10,45 cm  |
|  | Blood collection tube<br>2 mL to 5 mL<br>3/18      | <br>5804 738.004 | Round<br>Ø 13 mm<br>80 mm  | 14,339 × <i>g</i><br>17,065 × <i>g</i><br>10.6 cm   |

| Vessel  | Vessel<br><br>Capacity<br><br>Vessels per<br>adapter/rotor | Adapters<br><br>Order no.<br>(international)  | Adapter bottom<br>shape<br><br>Tube diameter<br><br>Max. tube length<br>with rotor lid | Max. <i>g</i> -force at 11,000 rpm<br>(5804/5804 R/5810)<br><br>Max. <i>g</i> -force at 12,100 rpm<br>(5810 R)<br><br>Centrifugation radius |
|---|--|---|--|---|
|    | Blood collection tube<br>4 mL to 7 mL<br>3/18              | <br>5804 739.000   | Round<br>Ø 13 mm<br>107 mm   | 15,442 × <i>g</i><br>18,353 × <i>g</i><br>11.4 cm   |
|    | Vessel<br>7 to 15 mL<br>2/12                               | <br>5804 771.001   | Round<br>Ø 16 mm<br>112 mm   | 15,150 × <i>g</i><br>18,000 × <i>g</i><br>11.2 cm   |
|    | Conical tube<br>15 mL<br>1/6                               | <br>5804 776.003   | conical<br>Ø 17.5 mm<br>123 mm   | 14,450 × <i>g</i><br>17,200 × <i>g</i><br>10.7 cm   |
|   | Vessel<br>15 to 18 mL<br>1/6                               | <br>5804 772.008  | Round<br>Ø 18 mm<br>123 mm   | 14,750 × <i>g</i><br>17,550 × <i>g</i><br>10.9 cm   |
|  | Vessel<br>20 mL to 30 mL<br>1/6                            | <br>5804 773.004 | Round<br>Ø 26 mm<br>123 mm   | 14,900 × <i>g</i><br>17,700 × <i>g</i><br>11.0 cm   |
|  | Vessel<br>50 mL<br>1/6                                     | <br>5804 774.000 | Round<br>Ø 29 mm<br>123 mm   | 15,157 × <i>g</i><br>18,014 × <i>g</i><br>11.2 cm   |
|  | Conical tube<br>50 mL<br>1/6                               | <br>5804 775.007 | conical<br>Ø 29.5 mm<br>121 mm   | 14,600 × <i>g</i><br>17,400 × <i>g</i><br>10.8 cm   |
|  | Vessel<br>85 mL<br>-/6                                     | -   | -<br>Ø 38 mm<br>121 mm   | 15,550 × <i>g</i><br>18,500 × <i>g</i><br>11.5 cm   |









# Centrifuge 5804/5804 R/5810/5810 R – Operating manual

EN

Operating manual



## 2.4.8 Rotors FA-45-30-11 and F-45-30-11

|   |  |   |
|---|--|---|
|  | <b>Rotor FA-45-30-11</b><br>Aerosol-tight fixed-angle rotor for 30 tubes | Max. <i>g</i> -force: 20,817 × <i>g</i> |
|   | <b>Rotor F-45-30-11</b><br>Fixed-angle rotor for 30 tubes                | Max. speed: 14,000 rpm                  |
|   | Max. load (adapter, tube and contents):                                  | 30 × 3.5 g                              |

| Vessel  | Vessel<br>Capacity<br><br>Vessels per<br>adapter/rotor | Adapters<br><br>Order no.<br>(international)  | Adapter bottom<br>shape<br><br>Tube diameter | Max. <i>g</i> -force<br><br>Max. speed<br><br>Centrifugation radius |
|---|--|---|--|---|
|    | Vessel<br>1.5/2 mL<br>-/30                             | -   | -<br>Ø 11 mm                                 | 20,817 × <i>g</i><br>14,000 rpm<br>9.5 cm                           |
|    | PCR tube<br>0.2 mL<br>1/30                             | <br>5425 715.005   | conical<br>Ø 6 mm                            | 16,200 × <i>g</i><br>14,000 rpm<br>7.4 cm                           |
|  | Vessel<br>0.4 mL<br>1/30                               | <br>5425 717.008 | conical<br>Ø 6 mm                            | 20,817 × <i>g</i><br>14,000 rpm<br>9.5 cm                           |
|  | Vessel<br>0.5 mL<br>1/30                               | <br>5425 716.001 | -<br>Ø 8 mm                                  | 18,400 × <i>g</i><br>14,000 rpm<br>8.4 cm                           |
|  | Microtainers<br>0.6 mL<br>1/30                         | <br>5425 716.001 | -<br>Ø 8 mm                                  | 20,817 × <i>g</i><br>14,000 rpm<br>9.5 cm                           |



## 2.4.9 Rotor F-45-48-PCR

|   |   |  |
|---|---|--|
|  | <b>Rotor F-45-48-PCR</b><br>Fixed-angle rotor for tube strips or 0.2 mL PCR tubes | Max. <i>g</i> -force: 15,294 × <i>g</i>  |
|   |   | Max. speed: 12,000 rpm                   |
|   |   | Max. load (tube and contents): 6 × 3.5 g |

| Vessel  | Vessel Capacity<br>Vessels per adapter/rotor                        | Adapters | Tube diameter | Max. <i>g</i> -force<br>Max. speed<br>Centrifugation radius |
|---|---|----------|---------------|---|
|  | 8-tube/5-tube tube strips<br>8/5 × 0,2 mL<br>-/6 × 8 and/or -/6 × 5 | -        | Ø 6 mm        | 15,294 × <i>g</i><br>12,000 rpm<br>9.5 cm                   |
|  | Vessel<br>0.2 mL<br>-/48  | -        | Ø 6 mm        | 15,294 × <i>g</i><br>12,000 rpm<br>9.5 cm                   |



## 2.4.10 Rotor T-60-11















|   |  |   |
|---|--|---|
|  | <b>Rotor T-60-11</b><br>Drum rotor for tubes | Max. <i>g</i> -force: 14,000 × <i>g</i> |
|   |  | Max. speed: 16,435 rpm                  |
|   |  | Max. load (tube and contents): 6 × 70 g |











| Vessel  | Vessel Capacity<br>Vessels per adapter/rotor | Adapters | Tube diameter | Max. <i>g</i> -force<br>Max. speed<br>Centrifugation radius |
|---|--|----------|---------------|---|
|  | Vessel<br>1.5/2 mL<br>10/60                  | -        | Ø 11 mm       | 16,435 × <i>g</i><br>14,000 rpm<br>7.5 cm                   |
|  | Vessel<br>0.4 mL<br>20/120                   | -        | Ø 6 mm        | 16,435 × <i>g</i><br>14,000 rpm<br>7.5 cm                   |



## 2.4.11 Rotor S-4-104 (only 5810/5810 R)

|   |   |   |  |  |
|---|---|---|--|--|
|  |  |  |  | Max. <i>g</i> -force: 3,214 × <i>g</i>                     |
| <b>Rotor S-4-104</b><br><br>Swing-bucket rotor with 4 × 750 mL round buckets      | <b>Round bucket 750 mL</b>  | <b>Aerosol-tight cap</b>  |  | Max. speed: 3,900 rpm                                      |
|   |   |   |  | Max. load per bucket (adapter, tube and contents): 1,000 g |

| Vessel  | Vessel<br>Capacity<br><br>Vessels per adapter/rotor                      | Adapters<br><br>Order no. (international)   | Adapter bottom shape<br><br>Tube diameter<br><br>Max. tube length with/without aerosol-tight bucket cap | Max. <i>g</i> -force<br><br>Max. speed<br><br>Centrifugation radius |
|---|--|---|---|---|
|   | Vessel<br>1.5/2 mL<br>62/248   | <br>5825 740.009  | continuous<br>Ø 11 mm<br>39 mm  | 3,197 × <i>g</i><br>3,900 rpm<br>18.8 cm                            |
|  | Vessel<br>5 mL<br>14/56  | <br>5825 739.000 | continuous<br>Ø 17 mm<br>60 mm  | 3,214 × <i>g</i><br>3,900 rpm<br>18.9 cm                            |
|  | Vessel<br>4 to 8 mL<br>23/92   | <br>5825 738.004 | round<br>Ø 13 mm × 100 mm<br>108 mm/115 mm  | 3,044 × <i>g</i><br>3,900 rpm<br>17.9 cm                            |
|  | Vessel<br>7,5 to 12 mL<br>20/80  | <br>5825 736.001 | round<br>Ø 16 mm × 98 mm<br>114 mm/119 mm   | 3,061 × <i>g</i><br>3,900 rpm<br>18 cm                              |
|  | Vessel<br>8 to 16 mL<br>7/28<br>Load inner bores only (Fig. 5 on p. 54). | <br>5825 736.001 | round<br>Ø 16 mm<br>(Do not use the aerosol-tight cap.)/<br>125 mm                                      | 3,061 × <i>g</i><br>3,900 rpm<br>18 cm                              |
|  | Vessel<br>9 mL<br><br>20/80  | <br>5825 743.008 | round<br>Ø 17.5 mm × 100 mm<br>106 mm/111 mm  | 3,044 × <i>g</i><br>3,900 rpm<br>17.9 cm                            |
|  | Conical tube<br>15 mL<br>14/56   | <br>5825 734.009 | conical<br>Ø 17 mm × 104 mm<br>120 mm/125 mm  | 3,197 × <i>g</i><br>3,900 rpm<br>18.8 cm                            |



| Vessel  | Vessel<br><br>Capacity<br><br>Vessels per<br>adapter/rotor | Adapters<br><br>Order no.<br>(international)  | Adapter bottom<br>shape<br><br>Tube diameter<br><br>Max. tube length<br>with/without<br>aerosol-tight<br>bucket cap | Max. <i>g</i> -force<br><br>Max. speed<br><br>Centrifugation radius |
|---|--|---|---|---|
|    | Conical tube<br>50 mL<br>7/28                              | <br>5825 733.002   | conical<br>Ø 29 mm × 109 mm<br>116 mm/122 mm  | 3,180 × <i>g</i><br>3,900 rpm<br>18.7 cm                            |
|    | Conical tube, skirted<br>50 mL<br>5/20                     | <br>5825 732.006   | conical<br>Ø 29 mm × 104 mm<br>116 mm/120 mm  | 3,027 × <i>g</i><br>3,900 rpm<br>17.8 cm                            |
|    | Centrifuge bottle<br>175 - 250 mL<br>1/4                   | <br>5825 741.005   | flat<br>Ø 62 mm × 129 mm<br>125 mm/145 mm   | 3,112 × <i>g</i><br>3,900 rpm<br>18.3 cm                            |
|  | Wide-neck bottle<br>750 mL<br>1/4                          | <br>5825 744.004 | flat<br>Ø 102 mm × 132 mm<br>132 mm/150 mm  | 3,146 × <i>g</i><br>3,900 rpm<br>18.5 cm                            |
|  | Centrifuge bottle<br>Corning<br>500 mL<br>1/4              | <br>5825 745.000 | conical<br>Ø 96 mm<br>(Do not use the<br>aerosol-tight cap.)/<br>147 mm   | 3,162 × <i>g</i><br>3,900 rpm<br>18.6 cm                            |









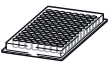
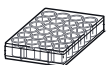
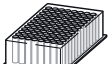
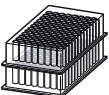

Only centrifuge conical tubes with the manufacturer's adapter.

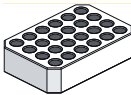

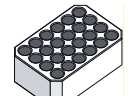

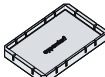
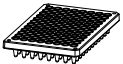
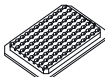
Do not use the aerosol-tight cap when using the Corning 50 mL conical tube.











|   |   |   |  |
|---|---|---|--|
|  |  |  | Max. <i>g</i> -force: 2,568 × <i>g</i>                       |
| <b>Rotor S-4-104</b><br>Swing-bucket rotor with 4 × plate buckets                 | <b>Plate bucket</b><br>(always use with a plate holder)                           | Aerosol-tight cap   | Max. speed: 3,900 rpm  |
|   |   |   | Max. load per bucket 450 g<br>(adapter, plate and contents): |









| Plate   | Plate<br>Capacity<br><br>Plates/slides per adapter/rotor | Adapters<br><br>Order no.<br>(international)  | Adapter bottom shape<br><br>Max. loading height | Max. <i>g</i> -force<br><br>Max. speed<br><br>Centrifugation radius |
|---|--|---|---|---|
|    | Micro test plate<br>96/384 wells<br>4/16                 | –   | –<br>–<br>47 mm/60 mm                           | 2,568 × <i>g</i><br>3,900 rpm<br>15.1 cm                            |
|  | Cell culture plate<br><br>2/8                            | –   | –<br>–<br>47 mm/60 mm                           | 2,568 × <i>g</i><br>3,900 rpm<br>15.1 cm                            |
|  | Deepwell plate<br>96 wells<br>1/4                        | –   | –<br>–<br>47 mm/60 mm                           | 2,568 × <i>g</i><br>3,900 rpm<br>15.1 cm                            |
|  | Kit<br><br>1/4   | –   | –<br>–<br>47 mm/60 mm                           | 2,568 × <i>g</i><br>3,900 rpm<br>15.1 cm                            |
|  | IsoRack<br>24 × 0.5 mL micro test tubes<br><br>1/4       |                  | open<br>Ø 6 mm<br><br>47 mm/60 mm               | 2,449 × <i>g</i><br>3,900 rpm<br>14.4 cm                            |
|  | IsoRack<br>24 × 1.5/2 mL micro test tubes<br><br>1/4     |                  | open<br>Ø 11 mm<br><br>47 mm/60 mm              | 2,381 × <i>g</i><br>3,900 rpm<br>14.0 cm                            |
|  | PCR plate<br>384 wells<br>1/4                            | <br>5825 713.001 | flat<br><br>47 mm/60 mm                         | 2,415 × <i>g</i><br>3,900 rpm<br>14.2 cm                            |
|  | PCR plate<br>96 wells<br>1/2                             | <br>5825 711.009 | conical<br><br>47 mm/60 mm                      | 2,449 × <i>g</i><br>3,900 rpm<br>14.4 cm                            |

| Plate  | Plate<br>Capacity<br>Plates/slides per adapter/rotor | Adapters<br>Order no.<br>(international)  | Adapter bottom shape<br>Max. loading height | Max. <i>g</i> -force<br>Max. speed<br>Centrifugation radius |
|--------|--|---|---|---|
| Slides | CombiSlide<br>12 slides<br>12/48                     | <br>5825 706.005 | flat<br>47 mm/60 mm                         | 1,000 × <i>g</i><br>2.467 rpm<br>14.7 cm                    |

### 2.4.12 Rotor S-4-72

|   |   |  |                  |
|---|---|--|------------------|
|  |  | Max. <i>g</i> -force:                              | 3,234 × <i>g</i> |
| <b>Rotor S-4-72</b>   | <b>Round bucket<br/>250 mL</b>  | Max. speed:  | 4,200 rpm        |
| Swing-bucket rotor with 4 × 250 mL round buckets                                  |   | Max. load per bucket (adapter, tube and contents): | 450 g            |

| Vessel  | Vessel<br>Capacity<br>Vessels per adapter/rotor | Adapters<br>Order no.<br>(international)  | Adapter bottom shape<br>Tube diameter<br>Max. tube length | Max. <i>g</i> -force<br>Max. speed<br>Centrifugation radius |
|---|---|---|---|---|
|  | Vessel<br>1.5/2 mL<br>26/104                    | <br>5804 794.001 | continuous<br>Ø 11 mm<br>43 mm                            | 3,136 × <i>g</i><br>4,200 rpm<br>15.9 cm                    |
|  | Vessel<br>5 mL<br>8/32                          | <br>5804 793.005 | conical<br>Ø 17 mm ×<br>60 mm                             | 3,215 × <i>g</i><br>4,200 rpm<br>16.3 cm                    |
|  | Vessel<br>4 to 8 mL<br>14/56                    | <br>5804 789.008 | Round<br>Ø 13 mm × 104 mm<br>115 mm                       | 3,136 × <i>g</i><br>4,200 rpm<br>15.9 cm                    |
|  | Vessel<br>7.5 to 12 mL<br>13/52                 | <br>5804 791.002 | Round<br>Ø 16 mm × 98 mm<br>112 mm                        | 3,096 × <i>g</i><br>4,200 rpm<br>15.7 cm                    |
|  | Vessel<br>9 mL<br>12/48                         | <br>5804 792.009 | Round<br>Ø 17.5 mm ×<br>100 mm<br>113 mm                  | 3,116 × <i>g</i><br>4,200 rpm<br>15.8 cm                    |





| Vessel   | Vessel<br><br>Capacity<br><br>Vessels per adapter/rotor  | Adapters<br><br>Order no.<br>(international)   | Adapter bottom shape<br><br>Tube diameter<br><br>Max. tube length | Max. <i>g</i> -force<br><br>Max. speed<br><br>Centrifugation radius |
|--|--|--|---|---|
|   | Conical tube<br>15 mL<br>8/32  | <br>5804 783.000  | conical<br>Ø 17 mm × 104 mm<br>120 mm                             | 3,234 × <i>g</i><br>4,200 rpm<br>16.4 cm                            |
|   | Conical tube<br>50 mL<br>4/16  | <br>5804 784.006  | conical<br>Ø 29 mm × 109 mm<br>120 mm                             | 3,234 × <i>g</i><br>4,200 rpm<br>16.4 cm                            |
|   | Conical tube, skirted<br>50 mL<br>2/8  | <br>5804 785.002  | conical<br>Ø 29 mm × 104 mm<br>120 mm                             | 3,027 × <i>g</i><br>3,900 rpm<br>17.8 cm                            |
|  | Centrifuge bottle<br>175 mL:<br>BD 352076<br>250 mL:<br>Nalgene 3120-0250/<br>3122-0250<br>1/4 | <br>5804 787.005 | Round<br>Ø 62 mm<br><br>130 mm                                    | 3,155 × <i>g</i><br>4,200 rpm<br><br>16 cm                          |



Only centrifuge conical tubes with the manufacturer's adapter.









## 2.4.13 Rotor F-35-48-17

|   |  |
|---|--|
|  | Max. <i>g</i> -force:            5,005 × <i>g</i>                    |
| <b>Rotor F-35-48-17</b><br>Fixed-angle rotor with 48 steel cores                  | Max. speed:                    5,500 rpm                             |
|   | Max. load (sleeve, adapter, tube and contents):            48 × 56 g |

| Vessel  | Vessel<br>Capacity<br><br>Vessels per adapter/rotor | Adapters<br><br>Order no. (international)   | Adapter bottom shape<br>Tube diameter<br><br>Max. tube length | Max. <i>g</i> -force<br><br>Max. speed<br><br>Centrifugation radius |
|---|---|---|---|---|
|    | Vessel<br>7,5 to 12 mL<br>1/48                      |    | flat<br>Ø 16 mm<br>127 mm                                     | 5,005 × <i>g</i><br>5,500 rpm<br>14.8 cm                            |
|  | Conical tube<br>15 mL<br>1/36                       |  | conical<br>Ø 17 mm<br>127 mm                                  | 5,005 × <i>g</i><br>5,500 rpm<br>14.8 cm                            |





## 2.4.14 Rotor FA-45-48-11

|   |   |
|---|---|
|  | Max. <i>g</i> -force: 19,083 × <i>g</i>                                       |
| <b>Rotor FA-45-48-11</b><br>Aerosol-tight fixed-angle rotor for 48 tubes          | Max. speed: 13,000 rpm<br>Max. load (adapter, tube and contents): 48 × 3.75 g |

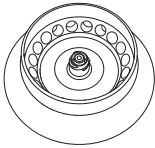
| Vessel  | Vessel<br>Capacity<br><br>Vessels per<br>adapter/rotor | Adapters<br><br>Order no.<br>(international)  | Adapter bottom<br>shape<br><br>Tube diameter | Max. <i>g</i> -force<br><br>Max. speed<br><br>Centrifugation radius |
|---|--|---|--|---|
|    | Vessel<br>1.5 to 2 mL<br>-/48                          |   | Round<br>Ø 11 mm                             | 19,083 × <i>g</i><br>13,000 rpm<br>10.1 cm                          |
|   | PCR tube<br>0.2 mL<br>1/48                             | <br>5425 715.005  | conical<br>Ø 6 mm                            | 15,115 × <i>g</i><br>13,000 rpm<br>8 cm                             |
|  | Vessel<br>0.4 mL<br>1/48                               | <br>5425 717.008 | conical<br>Ø 6 mm                            | 19,083 × <i>g</i><br>13,000 rpm<br>10.1 cm                          |
|  | Vessel<br>0.5 mL<br>1/48                               | <br>5425 716.001 | –<br>Ø 8 mm                                  | 17,005 × <i>g</i><br>13,000 rpm<br>9 cm                             |
|  | Vessel<br>0.6 mL<br>1/48                               | <br>5425 716.001 | –<br>Ø 8 mm                                  | 19,083 × <i>g</i><br>13,000 rpm<br>10.1 cm                          |

## 2.4.15 Rotor FA-45-20-17

|   |   |
|---|---|
|  | Max. <i>g</i> -force:            20,913 × <i>g</i>  |
| <b>Rotor FA-45-20-17</b><br>Aerosol-tight fixed-angle rotor for 20 tubes          | Max. speed:                    13,100 rpm<br>Max. load (adapter,<br>tube and contents):        20 × 9.5 g |

| <b>Vessel</b>   | <b>Vessel Capacity</b><br><b>Vessels per adapter/rotor</b> | <b>Adapters</b><br><b>Order no. (international)</b>   | <b>Adapter bottom shape</b><br><b>Tube diameter</b> | <b>Max. <i>g</i>-force</b><br><b>Max. speed</b><br><b>Centrifugation radius</b> |
|---|--|---|---|---|
|   | Vessel<br>1.5 mL/2.0 mL<br>1/20                            | <br>5820 768.002   | open<br>Ø 11 mm                                     | 18,227 × <i>g</i><br>13,100 rpm<br>9.5 cm                                       |
|  | Vessel<br>5 mL<br>-/20                                     | –   | conical<br>Ø 17 mm                                  | 20,913 × <i>g</i><br>13,100 rpm<br>10.9 cm                                      |
|   | HPLC vessels<br><br>1/20                                   | <br>5820 770.007 | open<br>Ø 11 mm                                     | 17,076 × <i>g</i><br>13,100 rpm<br>8.9 cm                                       |
|   | Cryo tube<br>1.0 mL/2.0 mL<br>1/12                         | <br>5820 769.009 | flat<br>Ø 13 mm                                     | 18,802 × <i>g</i><br>13,100 rpm<br>9.8 cm                                       |



## 3 Safety

### 3.1 Intended use

The 5804/5804 R/5810/5810 R centrifuge is intended exclusively for indoor use and for separating aqueous solutions and suspensions of various densities in approved test tubes.

### 3.2 User profile

This device may only be operated by trained specialist staff. They must have carefully read the operating manual and be familiar with the function of the device.

### 3.3 Application limits

#### 3.3.1 Declaration concerning the ATEX directive (94/9/EC)



##### **Risk of explosion.**

- ▶ Do not operate the device in areas where work is completed with explosive substances.
- ▶ Do not use this device to process any explosive or highly reactive substances.
- ▶ Do not use this device for processing any substances which could generate an explosive atmosphere.

Due to its design and the environmental conditions inside the device, the Centrifuge 5804/5804 R/5810/5810 R is not suitable for use in a potentially explosive atmosphere.

The device only must be used in a safe environment, such as the open environment of a ventilated laboratory or fume hood. The use of substances that may contribute to a potentially explosive atmosphere is not permitted. The user is responsible for making the final decision regarding the risks associated with the use of such substances.

#### 3.3.2 Maximum service life for accessories



##### **Risk of injury from chemically or mechanically damaged accessories.**

Even minor scratches and cracks can lead to serious internal material damage.

- ▶ Protect all accessory parts from mechanical damage.
- ▶ Inspect the accessories for damage before each use. Replace any damaged accessories.
- ▶ Do not use rotors, rotor lids, carriers, buckets, or caps with signs of corrosion or mechanical damage (e.g., deformations).
- ▶ Do not use any accessories which are past their use-by date.
- ▶ When inserting the buckets and rotors, ensure that they do not become scratched.



##### **Risk of injury due to chemically damaged rotor lids or caps.**

Transparent rotor lids or caps made from PC, PP or PEI may lose their strength under the impact of organic solvents (e.g. phenol, chloroform).

- ▶ If rotor lids or caps have come into contact with organic solvents, they should be cleaned immediately.
- ▶ Regularly check the rotor lids and caps for damages and cracks.
- ▶ Replace rotor lids or caps which show cracks or milky stains immediately.

The rotors listed below, and the corresponding buckets and rotor lids, have a maximum service life of the number of years or cycles listed in the table (whichever comes first), starting with the initial start-up.

| <b>Rotor</b> | <b>Maximum service from commissioning onward</b> |         |
|--------------|--|---------|
| A-2-DWP-AT   | 100,000 mechanical cycles                        | 7 years |
| A-2-DWP      | 34,000 mechanical cycles                         | 7 years |
| A-4-44       | 34,000 mechanical cycles                         | 7 years |
| A-4-62       | 40,000 mechanical cycles                         | 7 years |
| A-4-81       | 100,000 mechanical cycles                        | 7 years |
| F-34-6-38    | 75,000 mechanical cycles                         | 7 years |
| FA-45-6-30   |  | 7 years |
| FA-45-48-11  | 75,000 mechanical cycles                         | 7 years |
| FA-45-20-17  | 75,000 mechanical cycles                         | 7 years |
| F-35-48-17   | 75,000 mechanical cycles                         | 7 years |
| S-4-72       | 60,000 mechanical cycles                         | 7 years |
| S-4-104      | 100,000 mechanical cycles                        | 7 years |
| T-60-11      |  | 7 years |

| <b>Accessories</b>  | <b>Maximum service from commissioning onward</b> |         |
|---|--|---------|
| Aerosol-tight rotor lid, without replaceable seals  | 50 autoclaving cycles                            | –       |
| Rotor lid QuickLock   |  | 3 years |
| Seals of the QuickLock rotor lid  | 50 autoclaving cycles                            | –       |
| Rotor lid and caps made of polycarbonate (PC), polypropylene (PP) or polyetherimide (PEI) | 50 autoclaving cycles                            | 3 years |
| Adapters  | –  | 1 year  |

For all other rotors and rotor lids of this centrifuge there is no service life limit as long as the following requirements are met:

- Correct use,
- Recommended maintenance
- Undamaged condition

The date of manufacture is stamped on the rotors in the format 03/12 (= March 2012) or on the inside of the plastic rotor lids in the form of a clock ⌚.

To ensure aerosol tightness, the following applies:

- Replace aerosol-tight rotor lids and caps after 50 autoclaving cycles.
- Replace the seal of QuickLock rotor lids after 50 autoclaving cycles.

### 3.4 Information on product liability

In the following cases, the designated protection of the device may be compromised. Liability for any resulting property damage or personal injury is then transferred to the operator:

- The device is not used in accordance with the operating manual.
- The device is used outside of its intended use.
- The device is used with accessories or consumables which are not recommended by Eppendorf.
- The device is maintained or repaired by people not authorized by Eppendorf.
- The user makes unauthorized changes to the device.

## 3.5 Warnings for intended use

Read the operating manual and observe the following general safety instructions before using the 5804/5804 R/5810/5810 R centrifuge.

### 3.5.1 Personal injury or damage to the equipment



#### Electric shock due to damage to device or mains cable.

- ▶ Only switch on the device if the device and mains cable are undamaged.
- ▶ Only use devices that have been properly installed or repaired.
- ▶ In case of danger, disconnect the device from the mains supply by pulling the power plug from the device or the mains socket or, by using the isolating device intended for this purpose (e.g., emergency stop switch in the laboratory).



#### Lethal voltages inside the device.

- ▶ Ensure that the housing is always closed and undamaged so that no parts inside the device can be contacted by accident.
- ▶ Do not remove the housing of the device.
- ▶ Do not allow any liquids to penetrate the inside of the housing.
- ▶ Do not allow the device to be opened by anyone except service personnel who have been specifically authorized by Eppendorf.



#### Risk from incorrect supply voltage

- ▶ Only connect the device to voltage sources that match the electrical requirements listed on the name plate.
- ▶ Only use sockets with a protective earth (PE) conductor and suitable power cable.



#### Damages to health due to infectious liquids and pathogenic germs.

- ▶ When handling infectious liquids and pathogenic germs, observe the national regulations, the biological security level of your laboratory, the material safety data sheets, and the manufacturer's application notes.
- ▶ Use aerosol tight sealing systems for the centrifugation of these substances.
- ▶ When working with pathogenic germs belonging to a higher risk group, more than one aerosol-tight bioseal must be used.
- ▶ Wear personal protective equipment.
- ▶ Consult the "Laboratory Biosafety Manual" (Source: World Health Organization, Laboratory Biosafety Manual, as amended) for comprehensive regulations on the handling of risk group II germs or biological materials).



#### Crushing of the fingers with the centrifuge lid.

- ▶ When opening or closing the device lid, do not reach between the lid and device or into the latching mechanism of the lid.
- ▶ Always open the centrifuge lid completely to prevent it from falling.



**WARNING!**

### **A defective gas spring is an insufficient support for the centrifuge lid.**

A defective gas spring is an insufficient support for the centrifuge lid.

- ▶ Make sure that the centrifuge lid can be opened completely and that it will remain in this position.
- ▶ Regularly check the gas spring for its proper function.
- ▶ Have defective gas springs replaced immediately.

We recommend that the gas springs be replaced every 2 years by a service technician.



**CAUTION!**

### **Poor safety due to incorrect accessories and spare parts.**

The use of accessories and spare parts other than those recommended by Eppendorf may impair the safety, functioning and precision of the device. Eppendorf cannot be held liable or accept any liability for damage resulting from the use of incorrect or non-recommended accessories and spare parts, or from the improper use of such equipment.

- ▶ Only use accessories and original spare parts recommended by Eppendorf.



**NOTICE!**

### **Damage to device due to spilled liquids.**

1. Switch the device off.
2. Disconnect the device from the power supply.
3. Carefully clean the device and the accessories in accordance with the cleaning and disinfection instructions in the operating manual.
4. If a different cleaning and disinfecting method is to be used, contact Eppendorf AG to ensure that the intended method will not damage the device.



**NOTICE!**

### **Damage to electronic components due to condensation.**

Condensation can form inside the device after the device has been moved from a cool to a warmer environment.

- ▶ 5804/5810: Wait for at least 3 hours before connecting the device to the power supply.
- ▶ **5804/5810 only** : Alternative: Let the device heat up for 30 minutes right before a brief transport.
- ▶ 5804 R/5810 R: Wait for at least 4 hours before connecting the device to the power supply.



**NOTICE!**

### **Centrifuge 5804 R/5810 R: compressor damage after improper transport.**

- ▶ Only switch on the centrifuge 4 hours after installation.



**NOTICE!**

### **Buckets swinging out in the wrong direction.**

When working with the rotor S-4-104, using the wrong adapters with 500 mL Corning tubes may lead to the loss of samples or damage to the centrifuge.

- ▶ Only use the Eppendorf adapter intended for this purpose.

## **3.5.2 Incorrect handling of the centrifuge**



**NOTICE!**

### **Damage from knocking against or moving the device during operation.**

If the rotor bangs against the rotor chamber wall, it will cause considerable damage to the device and rotor.

- ▶ Do not move or knock against the device during operation.

## 3.5.3 Incorrect handling of the rotors



### Risk of injury from improperly attached rotors and rotor lids.

- ▶ Only centrifuge with rotor and rotor lid firmly tightened.
- ▶ If unusual noises occur when the centrifuge starts, the rotor or the rotor lid may not be properly secured. Immediately press the **start/stop** key to stop centrifuging.



### Risk of injury due to asymmetric loading of a rotor.

- ▶ Load rotors symmetrically with identical tubes or plates and buckets.
- ▶ Only load adapters with suitable tubes or plates.
- ▶ Always use tubes or plates of the same type (weight, material/density and volume).
- ▶ Check that loading is symmetrical by balancing the adapters and tubes or plates used with scales.



### Risk of injury from overloaded rotor.

The Centrifuge 5804/5804 R/5810/5810 R is designed for the centrifugation of centrifugation material with a max. density of 1.2 g/mL at maximum speed and volume.

- ▶ Please note the information on each rotor on the maximum load (adapter, tube and contents) per rotor bore and/or per bucket and do not exceed it.



### Damage to rotors from aggressive chemicals.

Rotors are high-quality components which withstand extreme stresses. This stability can be impaired by aggressive chemicals.

- ▶ Avoid the use of aggressive chemicals, including strong and weak alkali, strong acids, solutions with mercury, copper and other heavy metal ions, halogenated hydrocarbons, concentrated saline solutions and phenol.
- ▶ If the rotor is contaminated by aggressive chemicals, clean it immediately using a neutral cleaning agent. This applies to the rotor bores in particular.
- ▶ Due to the manufacturing process, color variations may occur on rotors marked "coated". These color variations do not effect service life or resistance to chemicals.



### If handled incorrectly, the rotor can fall over.

The buckets of the A-2-DWP, A-2-DWP-AT, S-4-104, A-4-44, A-4-62, S-4-72, A-4-81 may not be used as a handle.

- ▶ Before moving the rotor, remove the buckets.
- ▶ Always grip the rotor on the rotor cross using both hands.



### If handled incorrectly, the rotor can fall over.

- ▶ Always pick up the rotor F-35-48-17 with both hands.
- ▶ In order to hold the rotor safely, possibly you have to remove 3 to 4 sleeves from the opposite outer row.



### Risk of injury due to chemically damaged rotor lids or caps.

Transparent rotor lids or caps made from PC, PP or PEI may lose their strength under the impact of organic solvents (e.g. phenol, chloroform).

- ▶ If rotor lids or caps have come into contact with organic solvents, they should be cleaned immediately.
- ▶ Regularly check the rotor lids and caps for damages and cracks.
- ▶ Replace rotor lids or caps which show cracks or milky stains immediately.

## 3.5.4 Extreme strain on the centrifuging tubes



### Risk of injury from overloaded tubes.

- ▶ Note the loading limits specified by the tube manufacturer.
- ▶ Only use tubes which are approved by the manufacturer for the required rcf.



### Risk from damaged tubes.

Damaged tubes must not be used, as this could cause further damage to the device and the accessories and loss of the samples.

- ▶ Before use, visually check all of the tubes for damage.



### Risk from open tube lids.

Open tube lids can break off during centrifugation and damage both the rotor and the centrifuge.

- ▶ Carefully seal all tube lids before centrifuging.



### Hazard to plastic tubes from organic solvents.

The density of plastic tubes is reduced when organic solvents (e.g., phenol, chloroform) are used, i.e. the tubes could become damaged.

- ▶ Note the manufacturer's information on the chemical resistance of the tubes.



### Sample tubes heat up.

In uncooled centrifuges, the temperature in the rotor chamber, rotor and sample can increase to above 40 °C, based on the run time, *g*-force (rcf)/speed and ambient temperature.

- ▶ Note that this can reduce the centrifugation resistance of the sample tubes.
- ▶ Please note the temperature resistance of the samples.

### 3.5.5 Aerosol-tight centrifugation



**Risk to health due to limited aerosol tightness with incorrect rotor/rotor lid combination.**

Aerosol-tight centrifugation is guaranteed only if the rotors and rotor lids intended for this purpose are used. For fixed-angle rotors the labeling always begins with **FA**, swing-bucket rotors are labeled with **AT** (aerosol tight).

The aerosol-tight rotors and rotor lids of this centrifuge are additionally marked with a red ring on the rotor and a red rotor lid screw.

- ▶ For aerosol-tight centrifugation, always simultaneously use rotors and rotor lids which are marked as aerosol-tight in the centrifuge intended for the corresponding purpose. The details specifying in which centrifuge you may use the aerosol-tight rotors and rotor lids can be found on the rotor and, beginning from production date of October 2003, on the upper side of the rotor lid.
- ▶ Only use aerosol-tight rotor lids in combination with rotors which are marked on the rotor lid.
- ▶ Only use aerosol-tight rotors/buckets with the corresponding rotor lids/caps.



**Health hazard from limited aerosol-tightness due to incorrect use.**

Autoclaving, mechanical stresses and contamination by chemicals or other aggressive solvents can impair the aerosol-tightness of the rotors and rotor lid.

- ▶ Check the integrity of the seals of the aerosol-tight rotor lids or caps before each use.
- ▶ Only use aerosol-tight rotor lids or caps if the seals are undamaged and clean.
- ▶ Thinly brush the threads of the rotor lid screw with pivot grease (order no. Int. 5810 350.050, North America 022634330). Do not apply the pivot grease to the seals.
- ▶ Replace aerosol-tight rotor lids and caps after 50 autoclaving cycles.
- ▶ For QuickLock rotor lids, the seal must be replaced after 50 autoclaving cycles.
- ▶ **Never** store aerosol-tight rotors or buckets closed.

### 3.6 Safety instructions located on the device

| Display | Meaning  | Location                                |
|---------|--|---|
|         | Follow the instructions in the operating manual.                         | Right side of the device                |
|         | <b>CAUTION</b><br>Always tighten the rotor using the supplied rotor key. | Top of device, below the centrifuge lid |
|         | <b>CAUTION</b><br>Close all tubes and use a rotor lid.                   | Top of device, below the centrifuge lid |

## 4 Installation

### 4.1 Selecting the location



**If an error occurs, the objects in the immediate proximity of the device will be damaged.**

- ▶ In accordance with recommendations in EN 61010-2-020, leave a safety clearance of **30 cm** around the device during operation.
- ▶ Please remove all materials and objects from this area.



**Damage from overheating.**

- ▶ Do not install the device near to any heat sources (e.g., heating, drying cabinet).
- ▶ Do not expose the device to direct sunlight.
- ▶ Ensure unobstructed air circulation. Keep free a clearance of at least 30 cm around all ventilation grilles.



**Radio interference.**

This device is a category A product in accordance with EN 55011. There may be disturbance to radio reception in residential areas.

- ▶ Ensure that appropriate preventive measures are taken.

Select the location for the device according to the following criteria:

- Suitable power connection as per the name plate (230 V/120 V/100 V).
- Stable, horizontal and resonance-free lab bench. Weight of the device: 55 kg (5804) or 80 kg (5804 R), 68 kg (5810), 99 kg (5810 R).
- A well ventilated environment which is protected from direct sunlight to prevent the device from heating up more.

### 4.2 Preparing installation



**Bodily injury due to lifting and carrying heavy loads**

The device is heavy. Lifting and carrying the device can lead to back injuries.

- ▶ The device must be transported by least two people.
- ▶ Use a transport aid (e.g., dolly) to transport the device longer distances.

Perform the following steps in the sequence described.

1. Open the box.
2. Remove the covering cardboard.
3. Remove the accessories.
4. Lift the device by the underside in the vicinity of the device feet and place it directly on a suitable lab bench.





## 5 Operation

### 5.1 Overview of operating controls

Before using the centrifuge for the first time, familiarize yourself with the operating controls and the display.

The depiction of the operator panel and the device display can be found on the front fold-out page (s. Fig. 2 and Fig. 3).

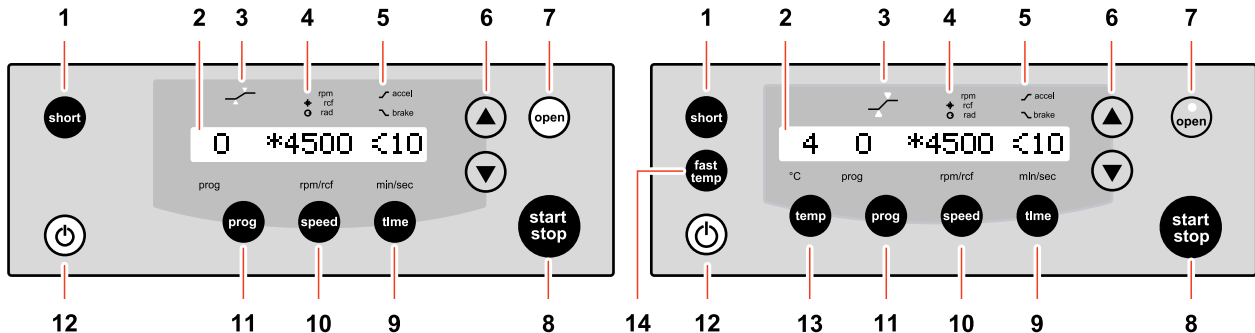

Fig. 2: Control panel of the Centrifuge 5804/5810 and the Centrifuge 5804 R/5810 R.

|   |  |
|---|--|
| 1 <b>Short spin centrifugation</b>  | 2 <b>Display</b>   |
| 3 <b>Status At set rpm function</b><br>: Start of run time when reaching 95% of the preset <i>g</i> -force (rcf) or speed (rpm). : Start of run time immediately. | 4 <b>Indicate speed (rpm), <i>g</i>-force (rcf) * and radius setting <math>\odot</math>.</b> |
| 5 <b>Symbol for acceleration  and braking .</b>   | 6 <b>Set parameters and values.</b>  |
| 7 <b>Release centrifuge lid.</b>  | 8 <b>Start or stop centrifugation.</b>   |
| 9 <b>Adjust centrifugation time.</b>  | 10 <b>Set centrifugation speed.</b>  |
| 11 <b>Select or save program.</b>   | 12 <b>Standby</b>  |
| 13 <b>Only 5804 R/5810 R: Set the temperature.</b>  | 14 <b>Only 5804 R/5810 R: Start temperature control run FastTemp.</b>                        |



Fig. 3: Display of Centrifuge 5804/5810 and the Centrifuge 5804 R/5810 R

|  |   |
|--|---|
| 1 <b>Program number</b>                              | 2 <b>Symbol for <i>g</i>-force (rcf)</b>      |
| 3 <b><i>g</i>-force (rcf)/rotational speed (rpm)</b> | 4 <b>Symbol flashes during centrifugation</b> |
| 5 <b>Symbol for acceleration  and braking .</b>      | 6 <b>Centrifugation time</b>                  |
| 7 <b>Only 5804 R/5810 R: Temperature</b>             |   |

The display of the centrifugation parameters changes depending upon the condition of the device:

- Rotor stop: display of set values.
- Centrifugation: display of actual values.

When you press the **temp**, **time** or **speed** keys during centrifugation, the respective set value is displayed for 2.5 seconds.

Please also read the precise description of the individual functions (see p. 60).

## 5.2 Preparing for centrifugation

### 5.2.1 Switching on the centrifuge

1. Switch on the centrifuge using the mains power switch or the  standby key.
2. Open the closed centrifuge lid by pressing the **open** key.  
The parameter settings of the last run are displayed.

### 5.2.2 Inserting the rotor

#### Prerequisites

When attaching the rotor to or releasing it from the motor shaft, the temperature of the rotor and motor shaft must be within the range of 10 – 30°C.



- ▶ **Swing-bucket rotors:** remove the buckets before inserting and/or removing the rotor. Use both hands to pick up the rotor cross.
- ▶ **Rotor F-35-48-17:** remove the sleeves before inserting and/or removing the rotor. Use both hands to pick up the rotor.

1. Fit the rotor vertically on the motor shaft.
2. Insert the supplied rotor key into the rotor nut.  
**Rotor cross A-4-81/S-4-104:** Use the special rotor key.
3. Turn rotor key **clockwise** until the rotor nut is firmly tightened.

### 5.2.3 Automatic rotor detection

The centrifuge has automatic rotor detection. It detects a newly inserted rotor and displays its maximum permitted speed for approx. 2 s. *g*-force (rcf) and speed (rpm) are automatically limited to the maximum permitted value for the rotor.

In order to trigger the rotor detection,

- ▶ press and hold the **start/stop** key with the centrifuge lid open and turn the rotor counterclockwise by hand.

The display shows the maximum permitted speed for the rotor. *g*-force (rcf) and speed (rpm) are automatically limited to the maximum permitted value for the rotor.

- ▶ Check the **At set rmp** setting.



Rotor detection can also be triggered by short spin centrifugation:

- ▶ Press the short key until the maximum permitted speed for the rotor appears in the display.



If you start centrifuging immediately after a rotor change, the centrifuge has not carried out an automatic rotor detection yet. The speed set for the previous rotor may exceed the maximum permitted speed for the new rotor. In this case, the centrifuge stops after the automatic rotor detection and displays *SPEED*. The new maximum permitted speed appears in the display.

Only select programs only after the automatic rotor detection.

You can then restart the centrifuging with these settings or adjust the speed as necessary.

- ▶ After each rotor change, check whether the new rotor is detected by the device.
- ▶ Check the set *g*-force (rcf) or speed (rpm) and adjust it if necessary.

## 5.2.4 Loading the rotor



### Risk of injury due to asymmetric loading of a rotor.

- ▶ Load rotors symmetrically with identical tubes or plates and buckets.
- ▶ Only load adapters with suitable tubes or plates.
- ▶ Always use tubes or plates of the same type (weight, material/density and volume).
- ▶ Check that loading is symmetrical by balancing the adapters and tubes or plates used with scales.



### Risk from damaged or overloaded tubes.

- ▶ When loading the rotor, observe the safety precautions on dangers as a result of overloaded or damaged tubes (see *Warnings for intended use on p. 43*).



The device automatically detects imbalances during operation and stops the run immediately with an error message and a signal tone.

- ▶ Check the load, balance the tubes and restart the run.

### Fixed-angle rotors



#### Rotor lid!

- Fixed-angle rotors may only be operated with the appropriate rotor lid in each case. This is clearly shown by the identical rotor name labeling on the rotor and on the rotor lid.
- To carry out an aerosol-tight centrifugation, an aerosol-tight rotor must be used in combination with the corresponding rotor lid or cap.

To load the rotor, proceed as follows:

1. Check the maximum load (adapter, tube and contents) per rotor bore.  
The information about this can be found on the rotor and in this operating manual (see *Rotors on p. 13*).
2. Load rotors and adapters only with the tubes intended for them.
3. Insert tubes opposite each other in pairs into the rotor bores. To ensure symmetric loading, tubes that are arranged opposite each other must be of the same type and contain the same filling quantity.

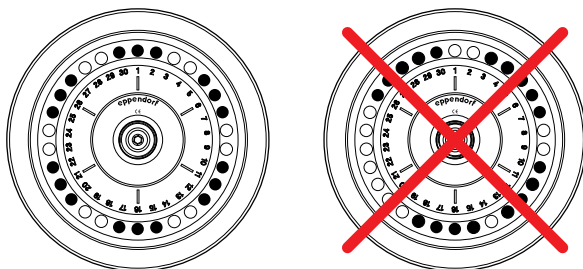

To minimize weight differences between filled sample tubes, we recommend taring with a scale. This will reduce wear on the drive and reduce running noise.

4. Attach and tighten rotor lid.

## Swing-bucket rotor

### Prerequisites

- A combination of rotor, carrier and adapter, approved by Eppendorf.
- The carriers are sorted by weight category. Carriers located opposite each other must belong to the same weight category. It is stamped onto the side of the groove, e.g. 68 (the last 2 digits in grams). When reordering - also plate carriers - make sure to specify the existing weight category.
- Matching and tested tubes and plates.
- Do not remove the middle guiding elements of the modular adapters of the rectangular buckets in order, e.g., to increase capacity through multi-level centrifugation.



### Damage to adapters due to incorrect stacking.

- ▶ Stack the adapters in rectangular buckets in a closed row only from the bottom of the bucket. Do not leave any gaps between the modules.



### Filling the plates too high can cause overflowing.

During the run the menisci in the tubes along the edges of the plates are at an angle. This is due to the centrifugal forces and cannot be avoided.

- ▶ Fill the wells of the plates to a maximum of 2/3 of the max. capacity.

To load the rotor, proceed as follows:

1. Check the carrier grooves for cleanliness and grease lightly with pivot grease (order no. Int.: 5810 350.050 / North America: 022634330). Dirty grooves and pivots prevent carriers from swinging out evenly.
2. Hang the buckets into the rotor. All rotor positions must be loaded with carriers.
3. Check that all carriers are hanging properly and can swing freely.

### Ensure that everything can swing freely

4. To check whether bottles, plates or tubes can swing freely, swing buckets manually.

### Check swinging direction

5. To check whether the buckets including their load swing with the floor in the direction of the rotor chamber wall, start turning the rotor cross anti-clockwise.
6. Check the maximum load per carrier (adapter, tube or plate and contents) and the loading height. The information about this can be found on the rotor and in this operating manual (see *Rotors on p. 13*).



### Broken glass due to incorrect loading

Adapter 16x 75 - 100 mm: when the outer bore ring is loaded with tubes >119 mm in length, there is the risk of glass breakages.

- ▶ Load the centre bore and the inner bore circle only.

7. Load the buckets symmetrically.

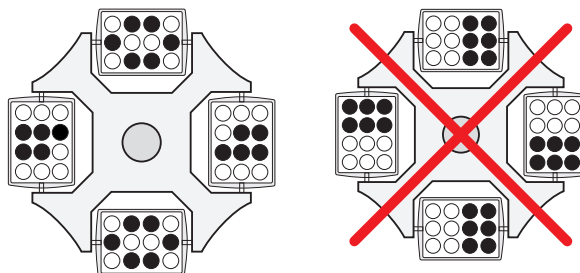

Fig. 4: Incomplete, but symmetric loading of the buckets. The pegs of each bucket must be uniformly loaded.

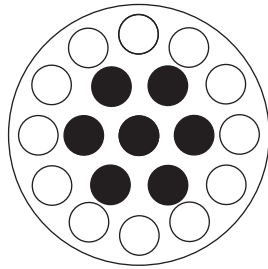

Fig. 5: Loading the adapter 16 mm 75 - 100 mm with tubes >119 mm in length.

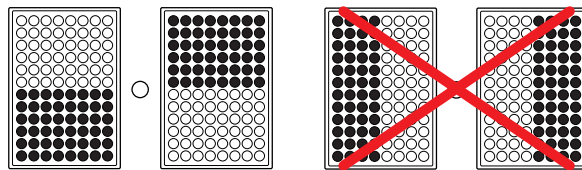

Fig. 6: Symmetrical loading of the plates.

The plate arrangement shown on the right-hand side is incorrect, as the buckets will not swing properly.

The same principle also applies to the loading of rotor A-4-81-MTP/Flex with 4 plates.

The plates have some play in the buckets.

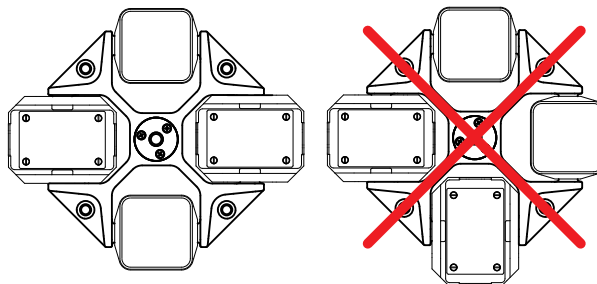

Fig. 7: Mixed loading of rotors

| Rotor                  | Mixing equipment  |
|------------------------|---|
| S-4-104                | <ul style="list-style-type: none"> <li>• 2 plate buckets (open bucket or plate bucket)</li> <li>• 2 round buckets</li> </ul>                                    |
| A-4-81/A-4-81-MTP/Flex | <ul style="list-style-type: none"> <li>• 2 plate buckets (MTP or DWP bucket)</li> <li>• 2 buckets for conical tubes</li> <li>• 2 rectangular buckets</li> </ul> |
| A-4-44                 | <ul style="list-style-type: none"> <li>• 2 rectangular buckets</li> <li>• 2 buckets for conical tubes</li> </ul>  |



**Rotor damage due to mixed loading.**

If you load the rotors A-4-62 and A-4-62-MTP with a mixed equipment, the rotors are damaged during centrifugation.

- ▶ Load all positions of the rotors A-4-62 and A-4-62-MTP with the same buckets.
- ▶ Always load all 4 positions of the swing-bucket rotors.

8. Check the loading of the bucket.

## 5.2.5 Closing the centrifuge lid



### Crushing of the fingers with the centrifuge lid.

- ▶ When opening or closing the device lid, do not reach between the lid and device or into the latching mechanism of the lid.
- ▶ Always open the centrifuge lid completely to prevent it from falling.

1. Check the correct attachment of the rotor and rotor lid.
2. Push down the centrifuge lid until the lid latch engages and the lid is automatically closed. The centrifuge will close automatically.  
The **open** key lights up blue. The ■ symbol appears in the display.

## 5.3 Cooling (only 5804 R/5810 R)

### 5.3.1 Temperature adjustment

- ▶ Select the temperature setting using the **temp** key.
- ▶ Set the temperature using the arrow keys between -9°C and +40°C.

### 5.3.2 Temperature display

If the rotor is stopped:                      Target temperature  
 During centrifugation:                      Actual temperature

### 5.3.3 Temperature monitoring

After the target temperature has been reached, the centrifuge reacts to temperature deviations during centrifugation as follows:

| Deviation from set value | Action  |
|--------------------------|---|
| ±3 °C                    | Temperatures on the display are flashing.                       |
| ±5 °C                    | Periodic warning tone. Centrifugation is stopped automatically. |

### 5.3.4 FastTemp

This function can be used to start a temperature control run directly without samples with a rotor and temperature-specific speed in order to quickly adjust the rotor chamber, including the rotor, buckets and adapters, to the previously set nominal temperature.

#### Prerequisites

- The centrifuge is switched on.
- The rotor and rotor lid are properly attached.
- The centrifuge lid is closed.
- Temperature and *g*-force (rcf)/speed (rpm) for the centrifugation are set (see *Centrifuging on p. 57*).

1. Press the **fast temp** key.  
 The display shows from left to right: actual temperature value, *FT*, *g*-force (rcf)/speed (rpm) and -- (time).  
 The temperature control run automatically ends when the set temperature is reached. A periodic signal tone sounds.

2. Press the **start/stop** key to terminate the temperature control run early.

After the set temperature has been reached and the temperature control run is complete, the centrifuge keeps the rotor chamber with the centrifuge lid closed at the set target temperature if the temperature is below the ambient temperature. However, independent of the target

temperature, 4 °C must be met via this continuous cooling in order to prevent the rotor chamber from freezing.



The centrifuge stops the cycle automatically if the rotor or the buckets have reached the set temperature. Therefore, there may be a delay of approx. 30 min between the display of the set temperature and the automatic end of the temperature control run.



When using aerosol-tight buckets, always carry out a FastTemp run at low temperatures without a cap. There is a danger otherwise of the caps becoming fixed by suction due to a vacuum. Do not pull on the sealing clamps or hooks to loosen the cap. Adjust the temperature of the buckets to room temperature so that the caps can be removed easily.

### 5.3.5 Continuous cooling

If the rotor stops, the rotor chamber will be maintained at the target temperature if the following requirements have been met:

- The centrifuge is switched on.
- The centrifuge lid is closed.
- The target temperature is lower than the ambient temperature.
- The centrifuge is not in standby mode.

During continuous cooling the following applies:

- The set and actual temperature are displayed alternately.
- Irrespective of the set temperature, the temperature does not go below 4 °C to prevent the rotor chamber from freezing and from increased condensation in the device.
- The temperature adjustment is slower because the rotor does not rotate during this process.

To end continuous cooling, open the centrifuge lid or press the standby key.

If the centrifuge is not used for more than 8 hours, the continuous cooling is switched off automatically (ECO shut-off). The device then switches to standby mode. This protects against ice formation in the rotor chamber and increased condensation in the device. With **FastTemp** you can quickly reach the desired temperature again (see p. 55).

You can also change from automatically switching off continuous cooling after 8 hours (ECO shut-off) to unlimited continuous cooling.



**NOTICE!**

#### Ice formation and compressor overheating during continuous cooling.

- ▶ Switch the centrifuge off regularly to eliminate any ice formation by thawing.
- ▶ Regularly remove condensation from the rotor chamber using a soft, absorbent cloth.
- ▶ Empty and clean the condensation water tray regularly.

1. When the centrifuge lid is opened, press the **temp** and **prog** keys simultaneously.  
*Standby 8h* appears in the display.
2. Press the **fast temp** key immediately.  
Endless operation for continuous cooling is activated. *Standby endless* appears in the display.
3. To change back to *Standby 8h*, repeat the process.



## 5.4 Centrifuging



### Risk from incorrectly-loaded rotors and damaged/overloaded tubes!

- ▶ Before commencing centrifugation, follow the safety instructions relating to risks from asymmetrically loaded and/or overloaded rotors and from overloaded, damaged and/or open tubes (see *Warnings for intended use on p. 43*).









### Risk of injury from improperly attached rotors, rotor lids and caps.

- ▶ Only centrifuge with firmly tightened rotor and rotor lid as well as with inserted carriers, buckets and correctly closed caps.
- ▶ If unusual noises occur when the centrifuge starts, the rotor, the rotor lid or a cap may not be properly secured. Immediately press the **start/stop** key to stop centrifuging.

Each of the centrifuging variants described here must be preceded by the preparation described above (see *Preparing for centrifugation on p. 51*).

### 5.4.1 Centrifuging with preset time

Perform the following steps in the sequence described.

-  1. Speed (rpm) setting: press once. *g*-force (rcf) setting: press repeatedly until the symbol \* additionally appears in the display.  
The displayed *g*-force (rcf)/speed (rpm) flashes and can be set with the arrow keys.  
For the *g*-force (rcf) setting also check the set radius (see *Rotors on p. 13*), (see *Setting the radius on p. 60*).
-  2. Use the arrow keys to set the *g*-force (rcf)/speed (rpm).  
The new set value appears in the display.
-  3. Select the runtime setting and set it with the arrow keys.
-  4. **Only 5804 R/5810 R:** Select the temperature setting and set it with the arrow keys.
-  5. Start centrifugation.
  - ■ blinks in the display when the rotor is running.
  - **Only 5804 R/5810 R:** The current temperature is displayed.
  - The current *g*-force (rcf)/speed (rpm) of the rotor is displayed.
  - You can display all set values for 2.5 s by pressing a parameter key (**Temp, Speed, Time**).
  - You can terminate centrifugation early by pressing the **start/stop** key.
  - After completion of the set time, the centrifuge stops automatically.
  - During braking the elapsed centrifugation time is displayed flashing.
-  6. Open the centrifuge lid as soon as the key lights up.



During the run you can modify the total run time, the temperature (only Centrifuge 5804 R/5810 R) and the *g*-force (rcf)/speed (rpm) as well as the acceleration time and the braking time. The new parameters are adopted immediately. The time which has already elapsed is considered in the newly set total run time. Note that the shortest new total runtime which can be set is the time which has already elapsed plus 2 minutes.

## 5.4.2 Centrifuging in continuous operation

Perform the following steps in the sequence described.

1. Set the *g*-force (rcf)/speed (rpm) and possibly the temperature as previously described (see p. 57).
2. Select the runtime setting.
3. Set continuous operation below 1 min or above 99 min.  
In the display ∞ indicates continuous run.
4. Start centrifugation.
  - ■ blinks in the display when the rotor is running.
  - If the centrifuge runs for more than 99 min, 99. appears in the display.
  - **Only 5804 R/5810 R:** The current temperature is displayed.
  - The current *g*-force (rcf)/speed (rpm) of the rotor is displayed.
5. End centrifugation after the desired time.
  - During braking the elapsed centrifugation time is displayed flashing.
6. Open the centrifuge lid as soon as the key lights up.

## 5.4.3 Short spin centrifugation

You can carry out a short spin centrifugation with the currently set or with the maximum *g*-force (rcf)/ speed (rpm) of the used rotor.

### Setting the speed option

- ▶ Press and hold down the key with the centrifuge lid open.  
One of the following options appears in the display:  
*rpm max*: the rotor accelerates up to its maximum *g*-force (rcf)/speed (rpm) (see *Rotors on p. 13*).  
*200 - rpm*: the rotor only accelerates up to its set *g*-force (rcf)/speed (rpm).
- ▶ Press and hold down the key for more than 3 s with the centrifuge lid open to switch between the *rpm max* and *200 - rpm* options.  
The selected option appears in the display for 2 s and is retained.

### Starting the short spin centrifugation

1. If *200 - rpm* is set, set the *g*-force (rcf)/ speed (rpm) for the short spin centrifugation (see p. 57).
2. **Only 5804 R/5810 R:** set the temperature (see p. 57).
3. Keep the key pressed to start the short spin centrifugation.
  - *SH* appears in the display while the rotor is running.
  - The time is counted upwards in seconds.
4. Release to end the short spin centrifugation.



During the braking process, centrifuging can be restarted up to two more times by pressing the **short** key again.



5. Open the centrifuge lid as soon as the key is illuminated.

## 5.4.4 Removing the rotor

### Prerequisites

When attaching the rotor to or releasing it from the motor shaft, the temperature of the rotor and motor shaft must be within the range of 10 – 30°C.



- ▶ **Swing-bucket rotors:** remove the buckets before inserting and/or removing the rotor. Use both hands to pick up the rotor cross.
- ▶ **Rotor F-35-48-17:** remove the sleeves before inserting and/or removing the rotor. Use both hands to pick up the rotor.

1. Turn the rotor nut with the rotor key **in a counterclockwise direction**.
2. Remove the rotor by lifting it vertically.
3. **Only 5804 R/5810 R:** Switch off the centrifuge after use and empty the condensation water tray. Leave centrifuge lid fully opened and protect it against closing.

## 5.4.5 Standby mode

- ▶ You can switch between standby mode and ready state at any time when centrifugation is not performed by pressing the standby key.

### Standby mode

- The display expires.
- The standby key lights red.
- **Only 5804 R/5810 R:** The rotor chamber is not cooled (see *Continuous cooling on p. 56*).





### Ready state

- The centrifugation parameters are displayed.
- The standby key lights green.
- **Only 5804 R/5810 R:** The rotor chamber is cooled when the centrifuge lid is closed (see *Continuous cooling on p. 56*).

## 6 Operating controls and function









### 6.1 Setting the radius

When you control the rotational speed via the *g*-force (rcf, RCF), and not via the speed (rpm), the internal conversion of speed to *g*-force takes place by default with the largest radius of the used rotor (see *Rotors on p. 13*). You can adapt this radius to an applied adapter:

-  1. Press several times until the symbol  also appears in the display.  
The current radius flashes.
-  2. Set the new radius.
-  3. Wait for 3 seconds (if the rotor is stopped: 10 seconds).  
The changed *g*-force appears.

### 6.2 Setting the acceleration and braking times

You can set the acceleration and braking time in the levels 0 to 9 (see Tab. on p. 73). Level 9 is preset (shortest acceleration and braking time).

-  1. Press twice until the  symbol for acceleration level (accel) appears in the display.
-  2. Select acceleration level 0 to 9.
-  3. Press once until the  symbol for braking level (brake) appears in the display.
-  4. Select braking level 0 to 9.  
Braking level (brake) 0 corresponds to free deceleration.  
The device only shows the  and  symbols continually when levels 0 to 8 have been set.

### 6.3 Setting the start of run time (At set rpm)

The centrifuge can count down the set time either immediately from the start of centrifugation or only once 95% of the specified *g*-force (rcf)/speed (rpm) has been reached (At set rpm). The respective setting is indicated by the flashing triangle in the symbol above the display:



Preset time: the set time is counted down immediately after the start of centrifugation.



At set rpm: the set time is counted down once 95% of the specified *g*-force (rcf)/speed (rpm) has been reached.

#### Prerequisites

The centrifuge lid is open.



- ▶ Hold down this key for at least 4 s to switch between the two settings,



When pressing the key, both triangles of the symbol will flash in turn.

## 6.4 Saving the program

You can save the current centrifugation parameters and functions (*At set rpm*, acceleration and braking times and radius) under up to 35 program numbers.

### Prerequisites

Rotor stop.

1. Check the parameters and functions to be saved.
2. Press key  twice.  
The first free program number appears with *P...* in the display.
3. Select the program number (*1...9, A...Z*).  

4. Press and hold key  for 2 seconds.  
*ok* appears in the display. The current centrifugation parameters and functions are saved under the selected program number.





When you want to overwrite a saved program, you have to delete it before saving the new parameters (see *Deleting the program on p. 61*).

## 6.5 Loading the program

### Prerequisites

- Rotor stop.

1. Press once key .  
Program number flashes:
  - *0*: centrifugation parameters and functions of the last run.
  - *1...9, A...Z*: stored programs.
2. Select the program number.  

3. Closed centrifuge lid: centrifugation starts with the loaded centrifugation parameters and functions.  
  
When the centrifuge lid is open, you can press the **start/stop** key to return to program 0 or exit the programming mode.





If you change the centrifugation parameters during a run with a stored program, the centrifuge changes to program *0*. The stored program remains unchanged.  
You can also exit the stored program by loading program *0*.

## 6.6 Deleting the program

### Prerequisites

- Rotor stop.
- The centrifuge lid is open.

1. Press once key .  
The program number flashes.
2. Select the program number.  

3. Within 10 seconds, keep key  pressed for 2 seconds.  
The following text appears in the display: *cleared*.  
The selected program is deleted. You can save new centrifugation parameters and functions under this program number.

## 6.7 Special functions

### 6.7.1 Display operating hours

#### Requirement

Rotor stop.



▶ Press both keys simultaneously.

The previous total run time of the centrifuge (in hours) appears in the display

### 6.7.2 Switching on/off the warning signal



▶ Press both keys simultaneously to change the setting.

*Alarm on* or *Alarm off* appears in the display after 2 s.

### 6.7.3 Exiting the service functions



▶ Press both keys simultaneously to exit a service program called by mistake.

### 6.7.4 Controlling the centrifuge via the serial interface (optional)

Optionally, you can also control all centrifuge functions via a serial interface (RS 232 c). For this a retrofit must be carried out by Eppendorf Service. Only devices verified according to IEC 950 must be connected to the serial interface.

## 7 Maintenance

### 7.1 Maintenance



#### A defective gas spring is an insufficient support for the centrifuge lid.

A defective gas spring is an insufficient support for the centrifuge lid.

- ▶ Make sure that the centrifuge lid can be opened completely and that it will remain in this position.
- ▶ Regularly check the gas spring for its proper function.
- ▶ Have defective gas springs replaced immediately.

We recommend that the gas springs be replaced every 2 years by a service technician.

We recommend that the centrifuge with the associated rotors be checked at the latest every 12 months by Technical Service during maintenance. Observe the relevant national regulations.

### 7.2 Prepare cleaning/disinfection

- ▶ Clean all accessible surfaces of the device and the accessories at least weekly and when contaminated.
- ▶ Clean the rotor regularly. This way the rotor is protected and the durability is prolonged.
- ▶ Furthermore, observe the notes on decontamination (see *Decontamination before shipment on p. 66*) when the device is sent to the authorized Technical Service for repairs.

The procedure described in the following chapter applies to the cleaning as well as to the disinfection or decontamination. The table below describes the steps required on top of this:

| Cleaning   | Disinfecting/decontamination  |
|--|---|
| <ol style="list-style-type: none"> <li>1. Use a mild cleaning fluid to clean the accessible surfaces of the device and the accessories.</li> <li>2. Carry out the cleaning as described in the following chapter.</li> </ol> | <ol style="list-style-type: none"> <li>1. Choose the disinfection method which corresponds to the legal regulations and guidelines in place for your range of application. For example, use alcohol (ethanol, isopropanol) or alcohol-based disinfectants.</li> <li>2. Carry out the disinfection or decontamination as described in the following chapter.</li> <li>3. Then clean the device and the accessories.</li> </ol> |



If you have any further questions regarding the cleaning and disinfection or decontamination or regarding the cleaning fluid to be used, contact the Eppendorf AG Application Support. The contact details are provided on the back of this manual.

## 7.3 Cleaning/disinfection



### Electric shock as a result of penetration of liquid.

- ▶ Switch off the device and disconnect the power plug before starting cleaning or disinfection work.
- ▶ Do not allow any liquids to penetrate the inside of the housing.
- ▶ Do not spray clean/spray disinfect the housing.
- ▶ Only plug the device back in if it is completely dry, both inside and outside.



### Damage from the use of aggressive chemicals.

- ▶ Do not use any aggressive chemicals on the device or its accessories, such as strong and weak bases, strong acids, acetone, formaldehyde, halogenated hydrocarbons or phenol.
- ▶ If the device has been contaminated by aggressive chemicals, immediately clean it by means of a mild cleaning agent.



### Corrosion from aggressive cleaning agents and disinfectants.

- ▶ Do not use corrosive cleaning agents, aggressive solvents or abrasive polishes.
- ▶ Do not incubate the accessories in aggressive cleaning agents or disinfectants for a longer period of time.



### Damage from UV and other high-energy radiation.

- ▶ Do not use UV, beta, gamma, or any other high-energy radiation for disinfecting.
- ▶ Avoid storage in areas with strong UV radiation



### Autoclaving

Except for the rotor crosses A-4-81, S-4-72 and S-4-104, all rotors, rotor lids, buckets, carriers, caps and adapters can be autoclaved (121 °C, 20 min).

After a maximum of 50 autoclaving cycles, the caps and, for QuickLock rotors, the seals must be replaced.

Do not use any stained, porous or otherwise defective seals. Also note the operating manual of the centrifuge and the supplement sheet on aerosol-tight centrifugation delivered together with the aerosol-tight rotors.

The aerosol-tight rotor FA-45-30-11 can be autoclaved at 142°C for 2 hours to destroy prions. In this case note that the rotor lid must be replaced after each autoclaving.



### Aerosol tightness

Check that the seals are intact before use.

Only QuickLock rotor lid: Replace the sealing ring in the lid groove when it becomes worn.

Replace the rotor lids with screw cap when the sealing rings on the lid screw and in the lid groove become worn.

The sealing rings require regular care to protect the rotors.

Aerosol-tight rotors should never be stored with lids screwed on!

In order to prevent damage, lightly lubricate the lid thread of the aerosol-tight rotors with pivot grease (order no. Int.: 5810 350.050/North America: 022634330).





## Swing-bucket rotor

- Before cleaning the rotor, remove old pivot grease from grooves and pivots.
- Make sure that the grooves and pivots are clean. Dirty grooves and pivots prevent carriers from swinging out evenly.
- After cleaning, lubricate the pivots of the rotor and the grooves of the buckets with pivot grease (order no. Int.: 5810 350.050/North America: 022634330) so that the carriers can move freely in a swinging manner.

### 7.3.1 Cleaning and disinfecting the device

1. Open the lid. Switch off the device with the mains/power switch. Disconnect the power plug from the power supply.
2. Loosen the rotor nut by turning the rotor key **counterclockwise**.
3. Remove the rotor.
4. Clean and disinfect all accessible surfaces of the device, including the power cable, using a damp cloth and the recommended cleaning agents.
5. Thoroughly clean the rubber seal of the rotor chamber with water.
6. Rub the dry rubber seal with glycerine or talcum powder to prevent it from becoming brittle. Other components of the device, such as the lid latch, lid springs, motor shaft and rotor cone, must not be lubricated.
7. Clean the motor shaft with a soft, dry and lint-free cloth. Do not lubricate the motor shaft.
8. Check the motor shaft for damage.
9. Inspect the device for corrosion and damage.
10. Leave the centrifuge lid open when the device is not being used.
11. Only connect the device to the power supply if it is fully dry inside and out.

### 7.3.2 Cleaning and disinfecting the rotor



After every 200 runs, the centrifuge displays *clean rotor* three times to remind you about the regular rotor cleaning.

1. Inspect the rotor and accessories for damage and corrosion. Do not use any damaged rotors or accessories.
2. Clean and disinfect the rotors and accessories with the recommended cleaning agents.
3. Use a bottle brush to clean and disinfect the rotor bores.
4. Rinse the rotors and accessories thoroughly with distilled water. Rinse the rotor bores of fixed-angle rotors particularly thoroughly.



Do not immerse the rotor in liquid as liquid can get trapped inside the cavities.

5. Place rotors and accessories on a cloth to dry. Place fixed-angle rotors with the rotor bores facing downwards to allow the bores to also dry.
6. Clean the rotor cone with a soft, dry and lint-free cloth. Do not lubricate the rotor cone.
7. Inspect the rotor cone for damage.
8. Place the dry rotor onto the motor shaft.
9. Tighten the rotor nut firmly by turning it **clockwise** with the rotor key.
10. Load the fixed-angle rotor with the cleaned adapters or the swing-bucket rotor with the cleaned buckets and adapters, if necessary.
11. Leave the rotor lid open when the rotor is not being used.

## 7.4 Additional service instructions for Centrifuge 5804 R/5810 R

- ▶ Empty and clean the condensation water tray regularly and especially after liquid spillage in the rotor chamber. Pull out the condensation water tray at the front right under the device.
- ▶ Clean the condensation water drain on a regular basis, e.g., using a bottle brush.
- ▶ Regularly free the rotor chamber ice formations via thawing, by leaving the centrifuge lid open or carrying out a short temperature control run at approx. 30 °C.
- ▶ Leave the centrifuge lid open when not in use for a long period.  
Residual moisture can escape. The gas lid spring is relieved.
- ▶ Wipe up condensate in the rotor chamber using a soft, absorbent cloth.
- ▶ Remove dust deposits from the ventilation slits of the centrifuge using a brush or swab at the latest every six months. First switch off the device and remove the power plug.

## 7.5 Glass breakage

When using glass tubes there is a risk of glass breakage in the rotor chamber. The resulting glass splinters are swirled around in the rotor chamber during centrifugation and have a sandblasting effect on the rotor and accessories. The smallest glass particles become lodged in the rubber parts (e.g., the motor guide, the rotor chamber seal, and the rubber mats of adapters).



**NOTICE!**

### Glass breakage in the rotor chamber

Glass tubes in the rotor chamber may break if the *g*-force is too high. Broken glass can damage the rotor, accessories and samples.

- ▶ Please note the manufacturer's information on the recommended centrifugation parameters (load and speed).

### Effects of glass breakage in the rotor chamber:

- Fine black metal abrasion in the rotor chamber (in metal rotor chambers)
- The surfaces of the rotor chamber and accessories are scratched.
- The chemical resistance of the rotor chamber is reduced.
- Contamination of samples
- Wear on rubber parts

### How to proceed in case of glass breakage

1. Remove all splinters and glass powder from the rotor chamber and accessories.
2. Thoroughly clean the rotor and rotor chamber. Thoroughly clean the bores of the fixed-angle rotors, in particular.
3. If required, replace the rubber mats and adapters to prevent any further damage.
4. Regularly check the rotor bores for deposits and damage.

## 7.6 Decontamination before shipment

If you are shipping the device to the authorized Technical Service for repairs or to your authorized dealer for disposal please note the following:



**WARNING!**

### Risk to health from contaminated device

1. Observe the notes on the decontamination certificate. You find it as a PDF file on our website ([www.eppendorf.com/decontamination](http://www.eppendorf.com/decontamination)).
2. Decontaminate all the parts you would like to dispatch.
3. Include the fully completed decontamination certificate in the package.

## 8 Troubleshooting

If you cannot remedy an error with the recommended measures, please contact your local Eppendorf partner. The contact address can be found online at: [www.eppendorf.com/worldwide](http://www.eppendorf.com/worldwide).

### 8.1 Resetting the excess current switch

The 230 V and 120 V devices have built-in thermal excess-current switches which function as (all-pole) fuses. When the overload protection is actuated, these switch the power switch to OFF, but do not switch it on again automatically.

To switch on the excess current switch again, proceed as follows:

1. Switch off the centrifuge using the power switch.
2. Wait for at least 20 seconds and switch on the centrifuge again.

The excess current switch will be automatically reactivated and the centrifuge is ready for operation.

### 8.2 General errors

| Symptom/message  | Cause  | Remedy  |
|--|--|---|
| No display.  | No mains power connection.   | ▶ Check the mains power connection.   |
| No display.  | Power failure.   | ▶ Check the mains fuse of the device (see <i>Resetting the excess current switch on p. 67</i> ).<br>▶ Check the mains fuse of the laboratory.   |
| Lid of the device cannot be opened.  | Rotor is still running.  | ▶ Wait for rotor to stop.   |
| Lid of the device cannot be opened.  | Power failure.   | 1. Check the mains fuse of the device (see <i>Resetting the excess current switch on p. 67</i> ).<br>2. Check the mains fuse of the laboratory.<br>3. Activate the emergency lid release (see p. 69). |
| <i>Clean rotor</i>   | 200 runs.  | ▶ Clean the rotor and chamber (see p. 63).  |
| Centrifuge brakes during a short run centrifugation, although the <b>short</b> key is pressed. | The <b>short</b> key was released briefly more than twice (protective function for the drive). | ▶ Press the <b>short</b> key continuously during a short run centrifugation.  |

### 8.3 Error messages

If one of the following error messages appears, proceed as follows:

1. Remove fault (see Remedy).
2. Press **open** key to clear the error message.
3. If necessary, repeat centrifugation.

Some errors can have various causes. The actual cause is described in the message in the device display.

| Symptom/message                                  | Cause     | Remedy              |
|--|-----------|---------------------|
| <i>No rotor</i><br>Centrifuge does not start up. | No rotor. | ▶ Insert the rotor. |

| Symptom/message   | Cause  | Remedy  |
|---|--|---|
| <i>No rotor</i><br>Centrifuge does not start up.  | Error in the drive or in the rotor detection.  | ▶ Switch the centrifuge off and back on again after > 20 s.   |
| <i>Press Open</i>   | Centrifuge lid could not be locked.  | 1. Press the <b>open</b> key.<br>2. Try again to close centrifuge lid.  |
| <i>Close lid</i>  | Centrifuge lid not closed properly.  | ▶ Close the centrifuge lid firmly.  |
| <i>Lift lid</i><br>The centrifuge lid does not open.  | The centrifuge lid cannot open automatically.  | ▶ Lift the centrifuge lid manually.   |
| <i>IMBAL</i><br>The centrifuge shakes when it starts up and switches off.                     | Rotor asymmetrically loaded.   | ▶ Load the rotor symmetrically (see p. 51).   |
| <i>ROTOR</i><br>The centrifuge shakes when it starts up and switches off.                     | Rotor not screwed sufficiently tight.  | 1. Tighten the rotor nut (see p. 51).<br>2. Check the rotor cone and motor shaft for grooves and damage.  |
| <i>ROTOR</i><br>The centrifuge shakes when it starts up and switches off.                     | <ul style="list-style-type: none"> <li>• Centrifuge was pushed.</li> <li>• Table is not stable.</li> </ul>   | ▶ Position the centrifuge on a stable table (see p. 48).  |
| <i>SPEED</i><br>Centrifuge switches off.  | Nominal speed for rotor too high.  | ▶ Enter the appropriate nominal speed (see p. 13).  |
| <i>change rotor</i>   | The maximum service life of the rotor has been reached. The warning is displayed after 98,000, 99,000 and 99,600 runs (3 times after each run). After 100,000 runs, it is displayed after every run. | ▶ Contact Technical Service.  |
| Temperature display flashes.<br>(only 5804 R/5810 R)  | Temperature deviation from the set value: $\pm 3$ °C.  | <ul style="list-style-type: none"> <li>▶ Check the settings.</li> <li>▶ Wait until the target temperature has been reached.</li> <li>▶ Check unhindered air circulation through the air slots.</li> <li>▶ Thaw ice or switch off device and allow it to cool down.</li> </ul> |
| <i>Overtemp</i><br>(only 5804 R/5810 R)<br>Centrifuge switches off and issues a warning tone. | Temperature deviation from set value in the rotor chamber: $\pm 5$ °C.   | <ul style="list-style-type: none"> <li>▶ Check the settings.</li> <li>▶ Check unhindered air circulation through the air slots.</li> <li>▶ Thaw ice or switch off device and allow it to cool down.</li> </ul>  |
| <i>Clear memory</i>   | Program memory full.   | ▶ Delete some programs (see p. 61).   |
| <i>Interrupt</i>  | Power failure during a run.  | ▶ Check the mains connection.   |
| <i>Error 1</i>  | Error in speed measuring system.   | ▶ If this error message appears again, test with a different rotor.   |
| <i>Error 2</i>  | Imbalance sensor faulty.   | ▶ Repeat the run.   |

| Symptom/message            | Cause  | Remedy   |
|----------------------------|--|--|
| <i>Error 3</i>             | Error in speed measuring system.   | ▶ Insert rotor and screw tight.  |
| <i>Error 3</i>             | Error in speed measuring system.   | ▶ Allow the centrifuge to stand for 12 min when switched on until the <b>open</b> key lights up.   |
| <i>Error 4</i>             | Lid latch sensor faulty.   | ▶ Switch the centrifuge off and back on again after > 20 s.  |
| <i>Error 5</i>             | Prohibited opening of lid or lid switch is defective during a run.   | <ol style="list-style-type: none"> <li>1. Wait for rotor to stop.</li> <li>2. Open and close again the lid of the device.</li> <li>3. Repeat the run.</li> </ol> |
| <i>Error 6 or overload</i> | Mains voltage too low.   | ▶ Check the mains voltage.   |
| <i>Error 6 or overload</i> | <ul style="list-style-type: none"> <li>• Converter overloaded.</li> <li>• Brake faulty.</li> </ul>                   | ▶ Switch off centrifuge, allow to cool down for at least 5 min, and then switch on again.  |
| <i>Error 8</i>             | <ul style="list-style-type: none"> <li>• Drive fault.</li> <li>• Rotor loose.</li> <li>• Motor defective.</li> </ul> | <ol style="list-style-type: none"> <li>1. Wait for rotor to stop.</li> <li>2. Tighten the rotor.</li> <li>3. Repeat the run.</li> </ol>                          |
| <i>Error 9 to Error 25</i> | Electronics fault.   | ▶ Switch the centrifuge off and back on again after > 20 s.  |

## 8.4 Emergency release

If the centrifuge lid cannot be opened, you can activate the emergency release manually.



### Risk of injury from rotating rotor.

- ▶ Wait until the rotor has come to a standstill before you operate the emergency release. The rotor can continue rotating for up to 8 min.
- ▶ To check, look through the inspection glass in the centrifuge lid.

You need the standard rotor key supplied with the centrifuge.

1. Disconnect the power plug.
2. Remove the plastic cover for the emergency release. This is located in the center on the front side of the device.
3. Insert the rotor key into the hexagonal opening behind until some resistance can be felt.
4. While keeping the rotor key pressed, turn it in a counterclockwise direction.  
This will release the centrifuge lid.
5. Open the centrifuge lid.
6. Remove the rotor key and put the plastic covers back on.

## 9 Transport, storage and disposal

### 9.1 Transport



#### Bodily injury due to lifting and carrying heavy loads

The device is heavy. Lifting and carrying the device can lead to back injuries.

- ▶ The device must be transported by least two people.
- ▶ Use a transport aid (e.g., dolly) to transport the device longer distances.

- ▶ Remove the rotor from the centrifuge before transport.
- ▶ Use the original packaging for transport.

|                   | Air temperature | Relative humidity | Atmospheric pressure |
|-------------------|-----------------|-------------------|----------------------|
| General transport | -25 °C – 60 °C  | 10 % – 75 %       | 30 kPa – 106 kPa     |
| Air freight       | -20 °C – 55 °C  | 10 % – 75 %       | 30 kPa – 106 kPa     |

### 9.2 Storage

|                             | Air temperature | Relative humidity | Atmospheric pressure |
|-----------------------------|-----------------|-------------------|----------------------|
| In transport packaging      | -25 °C – 55 °C  | 10 % – 75 %       | 70 kPa – 106 kPa     |
| Without transport packaging | -5 °C – 45 °C   | 10 % – 75 %       | 70 kPa – 106 kPa     |

### 9.3 Disposal

In case the product is to be disposed of, the relevant legal regulations are to be observed.

#### Information on the disposal of electrical and electronic devices in the European Community:

Within the European Community, the disposal of electrical devices is regulated by national regulations based on EU Directive 2002/96/EC pertaining to waste electrical and electronic equipment (WEEE).

According to these regulations, any devices supplied after August 13, 2005, in the business-to-business sphere, to which this product is assigned, may no longer be disposed of in municipal or domestic waste. To document this, they have been marked with the following identification:



Because disposal regulations may differ from one country to another within the EU, please contact your supplier if necessary.

## 10 Technical data

### 10.1 Power supply

|   |                                    |                            |
|---|------------------------------------|----------------------------|
| Power connection:                               | 230 V, 50 to 60 Hz<br>120 V, 60 Hz |                            |
| Current consumption:                            | 5804/5810 (230 V):                 | 6 A                        |
|   | 5804/5810 (120 V):                 | 11 A                       |
|   | 5804 R/5810 R (230 V):             | 9 A/10 A                   |
|   | 5804 R/5810 R (120 V), 20 A:       | 16 A                       |
|   | 5804 R/5810 R (120 V), 15 A:       | 12 A                       |
| Power consumption:                              | 5804/5810 (230 V):                 | max. 900 W                 |
|   | 5804/5810 (120 V):                 | max. 950 W                 |
|   | 5804 R/5810 R (230 V):             | max. 1650 W                |
|   | 5804 R/5810 R (120 V), 20 A:       | max. 1650 W                |
|   | 5804 R/5810 R (120 V), 15 A:       | max. 1300 W                |
| EMC: Interference emission (radio interference) | EN 61326-1 Class A                 |                            |
| EMC: Noise immunity                             | EN 61326                           |                            |
| Overvoltage category:                           | II                                 |                            |
| Fuses:  | 5804/5810 (230 V):                 | Excess current switch 12 A |
|   | 5804/5810 (120 V):                 | Excess current switch 12 A |
|   | 5804 R/5810 R (230 V):             | Excess current switch 12 A |
|   | 5804 R/5810 R (120 V), 20 A:       | Excess current switch 18 A |
|   | 5804 R/5810 R (120 V), 15 A:       | Excess current switch 15 A |

### 10.2 Ambient conditions

|                         |  |             |
|-------------------------|--|-------------|
| Environment:            | For indoor use only.                       |             |
| Ambient temperature:    | 5804/5810:                                 | 2 to 40 °C  |
|                         | 5804 R/5810 R:                             | 15 to 35 °C |
| Max. relative humidity: | 75%, non-condensing humidity               |             |
| Atmospheric pressure:   | Use up to an altitude of 2000 m above MSL. |             |
| Degree of pollution:    | 2  |             |

### 10.3 Weight/dimensions

|                           |        |  |
|---------------------------|--------|--|
| Dimensions<br>(W × D × H) | 5804   | 466 × 550 × 337 mm (18.4 × 21.7 × 13.3 in.)<br>Depth of footprint: 496 mm (19.5 in.) |
|                           | 5804 R | 634 × 550 × 342 mm (25.0 × 21.7 × 13.5 in.)<br>Depth of footprint: 496 mm (19.5 in.) |
|                           | 5810   | 535 × 608 × 345 mm (21.1 × 21.1 × 13.6 in.)<br>Depth of footprint: 536 mm (21.1 in.) |
|                           | 5810 R | 700 × 608 × 345 mm (27.6 × 23.9 × 13.6 in.)<br>Depth of footprint: 536 mm (21.1 in.) |

|                      |        |                        |                        |                          |
|----------------------|--------|------------------------|------------------------|--------------------------|
| Weight without rotor | 5804   | 55 kg (121 lb.)        |                        |                          |
|                      | 5804 R | 80 kg (176 lb.)        |                        |                          |
|                      | 5810   | 68 kg (150 lb.)        |                        |                          |
|                      | 5810 R | 99 kg (218 lb.)        |                        |                          |
| Rotor                |        |                        |                        |                          |
|                      |        | A-4-81<br>(4 × 500 mL) | A-4-44<br>(4 × 100 mL) | F-34-6-38<br>(6 × 85 mL) |
| Noise level          | 5804   | -                      | < 67 dB(A)             | < 51 dB(A)               |
|                      | 5804 R | -                      | < 56 dB(A)             | < 58 dB(A)               |
|                      | 5810   | < 65 dB(A)             | < 65 dB(A)             | < 53 dB(A)               |
|                      | 5810 R | < 56 dB(A)             | < 56 dB(A)             | < 59 dB(A)               |

The noise level was measured according to DIN EN ISO 3745 frontally in a sound measuring room with accuracy class 1 at a distance of 1 m from the device and at lab bench height.

## 10.4 Application parameters

|   |   |                        |  |
|---|---|------------------------|--|
| Runtime:  | 1 to 99 min, adjustable in 1 min increments.<br>infinite (∞)  |                        |  |
| Temperature (only 5804 R/<br>5810 R):   | -9 °C to 40 °C  |                        |  |
| Relative centrifugal force<br>(RCF or rcf):   | 10 to 20,913 × <i>g</i><br>adjustable up to 3,000 × <i>g</i> in 10 × <i>g</i> increments, thereafter in<br>100 × <i>g</i> increments.             |                        |  |
| Speed:  | 200 to 14,000 rpm,<br>adjustable up to 5,000 rpm <sup>&lt;Sup/&gt;</sup> in 10 rpm <sup>&lt;Sup/&gt;</sup> ,<br>afterwards in 100 rpm increments. |                        |  |
| Max. load:  | 5804/5804 R:  | 4 × 250 mL             |  |
|   | 5810/5810 R:  | 4 × 750 mL             |  |
| Max. kinetic energy:  | 5804/5810:  | 19,000 Nm (11,000 rpm) |  |
|   | 5804 R:   | 19,000 Nm (11,000 rpm) |  |
|   | 5810 R:   | 23,000 Nm (12,000 rpm) |  |
| Test log mandatory in Germany:  | Yes   |                        |  |
| Permitted density of the centrifugate<br>(at max. <i>g</i> -force/rpm and max. load): | 1.2 g/mL  |                        |  |
| Standardized interface (optional)   | RS 232 C  |                        |  |



### Deceleration times according to DIN 58 970

Tab. 2: Approximate deceleration times of the different rotors for the levels 0 to 9 (in seconds) for 230 V devices

| 5804/<br>5804 R | 5810/5810<br>R | Rotor                | 0   | 1   | 2   | 3   | 4   | 5         | 6   | 7   | 8   | 9   |
|-----------------|----------------|----------------------|-----|-----|-----|-----|-----|-----------|-----|-----|-----|-----|
| -               | ●              | A-4-81               | 532 | 189 | 174 | 143 | 131 | 109       | 95  | 85  | 59  | 31  |
| -               | ●              | A-4-81- MTP/<br>Flex | 643 | 191 | 174 | 142 | 131 | 110       | 94  | 83  | 58  | 30  |
| -               | ●              | A-4-62               | 740 | 190 | 170 | 140 | 130 | 110       | 95  | 85  | 55  | 26  |
| -               | ●              | A-4-62-MTP           | 620 | 190 | 170 | 140 | 130 | 110       | 95  | 85  | 55  | 26  |
| ●               | ●              | A-4-44               | 470 | 300 | 270 | 220 | 200 | 140       | 100 | 75  | 45  | 23  |
| -               | ●              | A-2-DWP-AT           | 857 | 231 | 202 | 176 | 157 | 135<br>μL | 112 | 102 | 69  | 39  |
| ●               | ●              | A-2-DWP              | 304 | 174 | 130 | 118 | 100 | 75        | 51  | 44  | 32  | 14  |
| ●               | ●              | FA-45-6-30           | 759 | 423 | 322 | 231 | 205 | 178       | 148 | 113 | 93  | 58  |
| ●               | ●              | F-34-6-38            | 880 | 370 | 280 | 190 | 170 | 150       | 125 | 95  | 75  | 54  |
| ●               | ●              | FA-45-30-11          | 240 | 140 | 70  | 45  | 35  | 30        | 25  | 22  | 19  | 18  |
| ●               | ●              | F-45-30-11           | 240 | 140 | 70  | 45  | 35  | 30        | 25  | 22  | 19  | 18  |
| ●               | ●              | F-45-48-PCR          | 169 | 119 | 60  | 41  | 31  | 26        | 22  | 19  | 17  | 16  |
| ●               | ●              | T-60-11              | 800 | 280 | 140 | 95  | 70  | 55        | 45  | 40  | 36  | 36  |
| -               | ●              | S-4-104              | 680 | 192 | 169 | 147 | 130 | 112       | 68  | 46  | 37  | 32  |
| ●               | ●              | S-4-72               | 360 | 238 | 191 | 168 | 148 | 117       | 56  | 32  | 21  | 15  |
| ●               | ●              | FA-45-48-11          | 454 | 269 | 141 | 98  | 76  | 62        | 46  | 40  | 35  | 31  |
| ●               | ●              | FA-45-20-17          | 550 | 342 | 178 | 123 | 97  | 80        | 58  | 51  | 45  | 40  |
| ●               | ●              | F-35-48-17           | 16  | 26  | 40  | 72  | 140 | 185       | 211 | 243 | 304 | 228 |

These values are to be considered as guidelines. Level 9 means "strongest braking", level 0 means "free deceleration". Considerable fluctuations can occur depending upon the condition of the device and the load. The deceleration times for the 230 and 120 V devices are almost identical.

## 11 Ordering information

### 11.1 Centrifuge 5804/5804 R

Please refer to our catalogue.

| Order no.<br>(international)                 | Order No.<br>(North America)        | Description   |
|--|-------------------------------------|---|
| 5804 000.013<br>5804 000.137                 | 022622552<br>022622501              | <b>Centrifuge 5804</b><br>without rotor<br>230 V/50 – 60 Hz<br>120 V, 50 Hz – 60 Hz   |
| 5805 000.017<br>5805 000.130<br>5805 000.530 | 022623559<br>022623508<br>022625080 | <b>Centrifuge 5804 R</b><br>refrigerated, without rotor<br>230 V/50 – 60 Hz<br>120 V/50 – 60 Hz, 15 A<br>120 V/50 – 60 Hz, 20 A |

### 11.2 Centrifuge 5810/5810 R

| Order no.<br>(international)                 | Order No.<br>(North America)        | Description   |
|--|-------------------------------------|---|
| 5810 000.017<br>5810 000.130                 | 022625055<br>022625004              | <b>Centrifuge 5810</b><br>without rotor<br>230 V/50 – 60 Hz<br>120 V/50 – 60 Hz, with US-plug   |
| 5811 000.010<br>5811 000.134<br>5811 000.533 | 022625551<br>022625501<br>022625101 | <b>Centrifuge 5810 R</b><br>refrigerated, without rotor<br>230 V/50 – 60 Hz<br>120 V/50 – 60 Hz, 15 A, with US-plug<br>120 V/50 – 60 Hz, 20 A, with US-plug |

### 11.3 Rotors and accessories

#### 11.3.1 Rotor A-4-81 (only 5810/5810 R)

**Rotor A-4-81, 500 mL bucket**

| Order no.<br>(international) | Order No.<br>(North America) | Description  |
|------------------------------|------------------------------|--|
| 5810 718.007<br>5810 743.001 | 022638602<br>022638611       | <b>Rotor A-4-81</b><br>for 500 mL rectangular buckets or MTP/Flex-buckets<br>incl. 4 × 500 mL rectangular buckets<br>without buckets |
| 5810 730.007                 | 022638629                    | <b>Rectangular bucket 500 mL</b><br>Set of 4   |
| 5810 724.007                 | 022638661                    | <b>Aerosol-tight cap</b><br>for 500 mL rectangular buckets, 2 pieces   |
| 5810 733.006                 | 022638670                    | <b>Replacement cap sealing for aerosol-tight caps</b><br>for 500 mL rectangular buckets, 4 pieces                                    |

| Order no.<br>(international)   | Order No.<br>(North America)  | Description   |
|--|---|---|
| 5810 745.004<br>5810 746.000<br>5810 720.001<br>5825 717.007<br>5810 748.003<br>5810 721.008<br>5810 722.004<br>5810 723.000<br>5810 739.004<br>5825 722.000<br>5810 728.002 | 022638704<br>022638707<br>022638700<br>022638718<br>022638721<br>022638726<br>022638742<br>022638769<br>022638904<br>022638921<br>022638785 | <b>Adapter</b><br>for 500 mL rectangular buckets<br>for 20 sample tubes (1.5/2.0 mL, max. Ø 11 mm), set of 2<br>for 20 blood collection tubes (1.2 – 5 mL, max. Ø 11 mm), set of 2<br>for 24 tubes (2.6 – 7 mL, max. Ø 13 mm), set of 2<br>for 18 tubes (5 mL, Monovette, max. Ø 13 mm), set of 2<br>for 16 blood collection tubes (3 – 15 mL, max. Ø 16 mm), set of 2<br>for 16 tubes (7 – 17 mL, max. Ø 17.5 mm), set of 2<br>for 12 conical tubes (15 mL, max. Ø 17.5 mm), set of 2<br>for 5 conical tubes (50 mL, max. Ø 31 mm), set of 2<br>for 5 Centriprep Centrifugal Filter Units (max. Ø 31 mm), set of 2<br>for 1 bottle (180 – 250 mL, max. Ø 62 mm), set of 2<br>for 1 bottle (400 mL, max. Ø 81 mm), set of 2 |
| 5804 737.008   | 022654373   | <b>Adapter</b><br>for 50 mL skirted conical tubes, set of 8   |
| 5810 734.002   | 022638688   | <b>Replacement rubber mat</b><br>for adapters for 500 mL rectangular buckets<br>set of 4  |
| 5810 735.009   | 022638696   | <b>Replacement clamp</b><br>for adapters for 500 mL rectangular buckets<br>2 pieces   |
| 5810 729.009<br>5820 707.003   | 022638653<br>022638657  | <b>Wide-neck bottle</b><br>for Rotor A-4-81<br>400 mL, set of 2<br>500 mL, rectangular, set of 2  |
| 5810 718.309   | 022664174   | <b>Rotor key</b><br>for Rotor A-4-81  |

### Rotor A-4-81, MTP/Flex carrier

| Order no.<br>(international) | Order No.<br>(North America) | Description   |
|------------------------------|------------------------------|---|
| 5810 725.003                 | 022638807                    | <b>Rotor A-4-81-MTP/Flex</b><br>Swing-bucket rotor, incl. 4 MTP/Flex buckets  |
| 5810 741.009<br>5810 742.005 | 022638840<br>022638866       | <b>Retrofit kit MTP/Flex buckets for Rotor A-4-81 or A-4-81-MTP/Flex</b><br>for use with IsoRack and cell culture flask adapters as well as MTP and DWP<br>set of 4<br>set of 2 |
| 5825 708.008<br>5825 709.004 | 022638980<br>022638998       | <b>IsoRack adapter</b><br>for 24 × 0.5 mL tubes in the IsoRack, set of 2<br>for 24 × 1.5/2.0 mL tubes in the IsoRack, set of 2  |
| 5825 721.004                 | 022510070                    | <b>IsoRack starter set for Flex buckets</b><br>2 × IsoRack Adapter, 2 × IsoRacks with lid, 2 × cool packs (0 °C IsoPack)<br>for 0.5 mL and 1.5/2.0 mL sample tubes              |
| 5825 711.009<br>5825 713.001 | 022638947<br>022638955       | <b>Adapter</b><br>used in A-4-81-MTP/Flex, A-4-62-MTP, A-2-DWP-AT and A-2-DWP<br>for 96-well PCR plates, set of 2<br>for 384-well PCR plates, set of 2                          |
| 5825 706.005                 | 022638963                    | <b>Adapter</b><br>used in A-4-81-MTP/Flex, A-4-62-MTP and A-2-DWP<br>CombiSlide Adapter, set of 2   |

| Order no.<br>(international) | Order No.<br>(North America) | Description   |
|------------------------------|------------------------------|---|
| 5825 719.000                 | 5825719000                   | <b>Adapter</b><br>used in A-4-81-MTP/Flex and A-4-62-MTP<br>for 1 cell culture bottle, set of 2 |

### Rotor A-4-81, bucket for conical tubes

| Order no.<br>(international) | Order No.<br>(North America) | Description   |
|------------------------------|------------------------------|---|
| 5825 730.003                 | 022638614                    | <b>Bucket for A-4-81</b><br>for 7 50 mL conical tubes, set of 4           |
| 5820 718.005                 | 5820718005                   | <b>Adapter</b><br>used in FA-45-6-30<br>for 15 mL conical tubes, set of 7 |

### 11.3.2 Rotor A-4-62 and A-4-62-MTP (only 5810/5810 R)

#### Rotor A-4-62

| Order no.<br>(international)   | Order No.<br>(North America)   | Description  |
|--|--|--|
| 5810 709.008   | 022638009  | <b>Rotor A-4-62</b><br>incl. 4 x 250 mL rectangular buckets  |
| 5810 716.004   | 022638084  | <b>Rectangular bucket 250 mL</b><br>Set of 4   |
| 5810 710.006   | 022638033  | <b>Aerosol-tight caps</b><br>for 250 mL rectangular buckets, set of 2  |
| 5810 713.005   | 022638017  | <b>Spare sealing for aerosol-tight caps</b><br>for 250 mL rectangular buckets<br>Set of 4  |
| 5810 751.004<br>5810 750.008<br>5810 752.000<br>5810 753.007<br>5810 754.003<br>5810 756.006<br>5810 757.002<br>5810 759.005<br>5810 760.003<br>5810 761.000<br>5810 770.009<br>5810 755.000<br>5810 758.009<br>5810 763.002 | 022638220<br>022638203<br>022638246<br>022638262<br>022638301<br>022638327<br>022638360<br>022638386<br>022638408<br>022638424<br>022638441<br>022638289<br>022638343<br>022638351 | <b>Adapter</b><br>for 250 mL rectangular buckets<br>for 16 sample tubes (1.5/2.0 mL, max. Ø 11 mm), set of 2<br>for 25 tubes (1.2 – 5 mL, max. Ø 11 mm), set of 2<br>for 15 tubes (2.6 – 7 mL, max. Ø 13 mm), set of 2<br>for 12 tubes (3 – 15 mL, max. Ø 16 mm), set of 2<br>for 12 tubes (7 – 17 mL, max. Ø 17.5 mm), set of 2<br>for 8 tubes (7 – 18 mL, max. Ø 20 mm), set of 2<br>for 4 tubes (18 – 30 mL, max. Ø 26 mm), set of 2<br>for 4 tubes (30 – 50 mL, max. Ø 31 mm), set of 2<br>for 2 tubes (50 – 75 mL, max. Ø 35 mm), set of 2<br>for 1 tube (80 – 120 mL, max. Ø 45 mm), set of 2<br>for 1 bottle (180 – 250 mL, max. Ø 62 mm), set of 2<br>for 9 conical tubes (15 mL, max. Ø 17.5 mm), set of 2<br>for 3 conical tubes (50 mL, max. Ø 31 mm), set of 2<br>for 4 conical tubes (50 mL), operation w/o aerosol-tight cap, set of 2 |
| 5804 737.008   | 022654373  | <b>Adapter</b><br>for 50 mL skirted conical tubes, set of 8  |
| 5810 782.007   | 022638483  | <b>Replacement rubber mat</b><br>for adapters for 250 mL rectangular buckets<br>Set of 4   |

| Order no.<br>(international) | Order No.<br>(North America) | Description   |
|------------------------------|------------------------------|---|
| 5810 781.000                 | 022662431                    | <b>Replacement clamp</b><br>for adapters for 250 mL rectangular buckets<br>Set of 2 |
| 5810 783.003                 | 022638459                    | <b>Replacement rubber mat</b><br>for adapter 5810 770.009/022638441<br>Set of 4     |

### Rotor A-4-62-MTP

| Order no.<br>(international) | Order No.<br>(North America) | Description  |
|------------------------------|------------------------------|--|
| 5810 711.002                 | 022638041                    | <b>Rotor A-4-62-MTP</b><br>incl. 4 MTP buckets   |
| 5810 702.003                 | 022638068                    | <b>Replacement MTP bucket for A-4-62</b><br>for 4 MTP or 1 DWP<br>Set of 4   |
| 5825 711.009<br>5825 713.001 | 022638947<br>022638955       | <b>Adapter</b><br>used in A-4-81-MTP/Flex, A-4-62-MTP, A-2-DWP-AT and A-2-DWP<br>for 96-well PCR plates, set of 2<br>for 384-well PCR plates, set of 2 |
| 5825 706.005                 | 022638963                    | <b>Adapter</b><br>used in A-4-81-MTP/Flex, A-4-62-MTP and A-2-DWP<br>CombiSlide Adapter, set of 2  |

### 11.3.3 Rotor A-4-44

| Order no.<br>(international)   | Order No.<br>(North America)   | Description  |
|--|--|--|
| 5804 709.004   | 022637401  | <b>Rotor A-4-44</b><br>incl. 4 x 100 mL rectangular buckets  |
| 5804 741.005   | 022637436  | <b>Rectangular bucket 100 mL</b><br>set of 4   |
| 5804 712.005   | 022637428  | <b>Aerosol-tight cap</b><br>for 100 mL rectangular buckets, set of 2   |
| 5804 713.001   | 022637444  | <b>4 Replacement gasket for aerosoltight caps</b><br>for 100 mL rectangular buckets, set of 4  |
| 5804 751.000<br>5804 750.004<br>5804 752.007<br>5804 753.003<br>5804 754.000<br>5804 756.002<br>5804 757.009<br>5804 759.001<br>5804 760.000<br>5804 761.006<br>5804 755.006<br>5804 717.007<br>5804 758.005<br>5804 718.003 | 022637525<br>022637509<br>022637541<br>022637568<br>022637584<br>022637622<br>022637649<br>022637681<br>022637703<br>022637720<br>022637606<br>022637614<br>022637665<br>022637673 | <b>Adapter for 100 mL rectangular bucket</b><br>for 12 sample tubes (1.5/2.0 mL, max. Ø 11 mm), set of 2<br>for 14 tubes (1.2 – 5 mL, max. Ø 11 mm), set of 2<br>for 9 tubes (2.6 – 7 mL, max. Ø 13 mm), set of 2<br>for 7 tubes (3 – 15 mL, max. Ø 16 mm), set of 2<br>for 6 tubes (7 – 17 mL, max. Ø 17.5 mm), set of 2<br>for 4 tubes (7 – 18 mL, max. Ø 20 mm), set of 2<br>for 2 tubes (18 – 30 mL, max. Ø 26 mm), set of 2<br>for 1 tube (30 – 50 mL, max. Ø 31 mm), set of 2<br>for 1 tube (50 – 75 mL, max. Ø 35 mm), set of 2<br>for 1 tube (80 – 100 mL, max. Ø 45 mm), set of 2<br>for 4 conical tubes (15 mL, max. Ø 17.5 mm), set of 2<br>for 2 conical tubes (15 mL, max. Ø 17.5 mm), set of 2<br>for 1 conical tube (50 mL, max. Ø 31 mm), set of 2<br>for 1 conical tube (50 mL, max. Ø 31 mm), set of 2 |

| Order no.<br>(international) | Order No.<br>(North America) | Description   |
|------------------------------|------------------------------|---|
| 5804 737.008                 | 022654373                    | <b>Adapter</b><br>for 50 mL skirted conical tubes, set of 8   |
| 5804 782.003                 | 022662503                    | <b>Rubber mat</b><br>for adapters of Rotor A-4-44<br>Set of 4   |
| 5804 781.007                 | 022662511                    | <b>Replacement clamp</b><br>for adapters of rotor A-4-44<br>Set of 2  |
| 5804 706.005                 | 022637452                    | <b>Bucket for A-4-44</b><br>for 2 Falcon tubes (50 mL, max. Ø 31 mm), set of 4                                      |
| 5804 728.009                 | 022637479                    | <b>Adapter</b><br>Form inserts for buckets with conical tubes<br>for 1 conical tube (50 mL, max. Ø 31 mm), set of 8 |

### 11.3.4 Rotor A-2-DWP-AT (only 5810/5810 R)

| Order no.<br>(international) | Order No.<br>(North America) | Description  |
|------------------------------|------------------------------|--|
| 5820 710.004                 | 5820710004                   | <b>Rotor A-2-DWP-AT</b><br>incl. 2 buckets, 2 aerosol-tight caps and 2 plate holders   |
| 5820 711.000                 | 5820711000                   | <b>Bucket for rotor A-2-DWP-AT</b><br>2 pieces   |
| 5820 713.003                 | 5820713003                   | <b>Aerosol-tight bucket cap, Rotor A-2-DWP-AT</b><br>2 pieces  |
| 5820 705.000                 | 5820705000                   | <b>Spare seal for aerosoltight cap</b><br>2 pieces   |
| 5820 756.004                 | 5820756004                   | <b>Plate holder for plate bucket</b><br>for rotor S-4-104 and Rotor A-2-DWP-AT<br>Set of 2 pieces  |
| 5825 711.009<br>5825 713.001 | 022638947<br>022638955       | <b>Adapter</b><br>used in A-4-81-MTP/Flex, A-4-62-MTP, A-2-DWP-AT and A-2-DWP<br>for 96-well PCR plates, set of 2<br>for 384-well PCR plates, set of 2 |

Aerosol impermeability tested and certified by the Centre of Emergency Preparedness and Response, Health Protection Agency, Porton Down (UK).

### 11.3.5 Rotor A-2-DWP

| Order no.<br>(international) | Order No.<br>(North America) | Description  |
|------------------------------|------------------------------|--|
| 5804 740.009                 | 022638564                    | <b>Rotor A-2-DWP</b><br>Deepwell plates rotor, incl. 2 buckets           |
| 5804 743.008                 | 022638556                    | <b>Deepwell plate bucket</b><br>used in A-2-DWP<br>set of 2              |
| 5825 718.003                 | 5825718003                   | <b>SBS adapter</b><br>for plates with rims in the SBS format<br>Set of 2 |

| Order no.<br>(international) | Order No.<br>(North America) | Description  |
|------------------------------|------------------------------|--|
| 5825 708.008<br>5825 709.004 | 022638980<br>022638998       | <b>IsoRack adapter</b><br>for 24 × 0.5 mL tubes in the IsoRack, set of 2<br>for 24 × 1.5/2.0 mL tubes in the IsoRack, set of 2                         |
| 5825 711.009<br>5825 713.001 | 022638947<br>022638955       | <b>Adapter</b><br>used in A-4-81-MTP/Flex, A-4-62-MTP, A-2-DWP-AT and A-2-DWP<br>for 96-well PCR plates, set of 2<br>for 384-well PCR plates, set of 2 |
| 5825 706.005                 | 022638963                    | <b>Adapter</b><br>used in A-4-81-MTP/Flex, A-4-62-MTP and A-2-DWP<br>CombiSlide Adapter, set of 2  |

### 11.3.6 Rotor FA-45-6-30

| Order no.<br>(international)   | Order No.<br>(North America)   | Description  |
|--|--|--|
| 5820 715.006   | 5820715006   | <b>Rotor FA-45-6-30</b><br>aerosol-tight*, aluminum, 45° angle, 6 places, for 15/ 50 mL conical tubes, incl. rotor lid (aluminum)  |
| 5820 716.002   | 5820716002   | <b>Rotor lid for FA-45-6-30</b><br>aerosol-tight, aluminum   |
| 5418 709.008   | 022652109  | <b>Seal for rotor lid</b><br>FA-45-18-11 (5418/5418 R), FA-45-6-30 (5804/5804 R/5810/5810 R)<br>set of 5 pieces  |
| 5820 717.009<br>5820 720.000<br>5820 721.006<br>5820 722.002<br>5820 730.005<br>5820 726.008<br>5820 725.001<br>5820 728.000 | 5820717009<br>5820720000<br>5820721006<br>5820722002<br>5820730005<br>5820726008<br>5820725001<br>5820728000 | <b>Adapter</b><br>used in rotor FA-45-6-30<br>for 1 conical tubes 15 mL (max. Ø 17 mm), set of 2 pieces<br>for 1 Oak Ridge 16 mL (max. Ø 18 mm), set of 2 pieces<br>for 1 Oak Ridge 30 mL (max. Ø 26 mm), set of 2 pieces<br>for 1 Oak Ridge 35 mL (max. Ø 30 mm), set of 2 pieces<br>for 1 tube 5 mL (max. Ø 17 mm), set of 2 pieces<br>for 1 round-bottom and blood collection tube (13 mm x 75 mm), set of 2 pieces<br>for 1 round-bottom and blood collection tube (13 mm x 100 mm), set of 2 pieces<br>for 1 Oak Ridge 10 mL, round-bottom and blood collection tube (13 mm x 75 mm), set of 2 pieces<br>for 1 round-bottom and blood collection tube (16 mm x 100 mm), set of 2 pieces<br>for 1 round-bottom and blood collection tube (17,5 mm x 100 mm), set of 2 pieces |

Aerosol impermeability tested and certified by the Centre of Emergency Preparedness and Response, Health Protection Agency, Porton Down (UK).

### 11.3.7 Rotor F-34-6-38

| Order no.<br>(international) | Order No.<br>(North America) | Description  |
|------------------------------|------------------------------|--|
| 5804 727.002                 | 022637207                    | <b>Rotor F-34-6-38</b><br>34° angle, 6 places for 85 mL tubes, incl. rotor lid |
| 5804 727.509                 | 022662961                    | <b>Rotor lid for F-34-6-38</b>   |

| Order no.<br>(international) | Order No.<br>(North America) | Description  |
|------------------------------|------------------------------|--|
| 5804 770.005                 | 022637215                    | <b>Adapter</b><br>used in F-34-6-38<br>for 4 sample tubes 1.5/2.0 mL (max. Ø 11 mm), set of 2<br>for 1 tube 5 mL (max. Ø 17 mm), set of 2 pieces<br>for 3 round-bottom and blood collection tubes (13 x 75 mm), set of 2 pieces<br>for 3 round-bottom and blood collection tubes (13 x 100 mm), set of 2 pieces<br>for 2 tubes (7 bis 15 mL, max. Ø 16 mm), set of 2<br>for 1 conical tube (15 mL, max. Ø 17 mm), set of 2<br>for 1 tube (15 bis 18 mL, max. Ø 18 mm), set of 2<br>for 1 tube (20 bis 30 mL, max. Ø 26 mm), set of 2<br>for 1 tube (50 mL, max. Ø 29 mm), set of 2<br>for 1 conical tube (50 mL, max. Ø 29.5 mm), set of 2 |
| 5804 777.000                 | 5804777000                   |  |
| 5804 738.004                 | 022637279                    |  |
| 5804 739.000                 | 022637282                    |  |
| 5804 771.001                 | 022637223                    |  |
| 5804 776.003                 | 022637274                    |  |
| 5804 772.008                 | 022637231                    |  |
| 5804 773.004                 | 022637240                    |  |
| 5804 774.000                 | 022637258                    |  |
| 5804 775.007                 | 022637266                    |  |

### 11.3.8 Rotor FA-45-30-11 and rotor F-45-30-11

| Order no.<br>(international) | Order No.<br>(North America) | Description   |
|------------------------------|------------------------------|---|
| 5804 726.006                 | 022637100                    | <b>Rotor FA-45-30-11</b><br>aerosol-tight*, 45° angle, 30 places for 1.5/2.0 mL tubes, incl. rotor lid (aluminum)   |
| 5804 736.001                 | 022637126                    | <b>Rotor lid for FA-45-30-11</b><br>aerosol-tight, aluminum   |
| 5804 715.004                 | 022637002                    | <b>Rotor F 45-30-11</b><br>45° angle, 30 places for 1.5/2.0 mL tubes, incl. rotor lid (aluminum)  |
| 5804 715.403                 | 022662970                    | <b>Rotor lid for F-45-30-11</b><br>not aerosol-tight, aluminum  |
| 5425 715.005                 | 022636260                    | <b>Adapter</b><br>used in FA-45-30-11 and F-45-30-11<br>for 1 PCR tube (0.2 mL, max. Ø 6 mm), set of 6<br>for 1 sample tube (0.4 mL, max. Ø 6 mm), set of 6<br>for 1 sample tube (0.5 mL, max. Ø 6 mm) or 1 Microtainer (0.6 mL, max. Ø 8 mm), set of 6 |
| 5425 717.008                 | 022636243                    |   |
| 5425 716.001                 | 022636227                    |   |

### 11.3.9 Rotor F-45-48-PCR

| Order no.<br>(international) | Order No.<br>(North America) | Description  |
|------------------------------|------------------------------|--|
| 5804 735.005                 | 022638581                    | <b>Rotor F-45-48-PCR</b><br>45° angle, for 6 x 8-tube strips, 6 x 5-tube strips or 48 x 0.2 mL PCR tubes |

### 11.3.10 Rotor T-60-11

| Order no.<br>(international) | Order No.<br>(North America) | Description  |
|------------------------------|------------------------------|--|
| 5804 730.003                 | 022638505                    | <b>Rotor T 60-11</b><br>for 60 x 1.5/2.0 mL tubes<br>incl. rotor lid, and 6 adapters for 1.5/2 mL sample tubes                                       |
| 5804 731.000                 | 022638521                    | <b>Adapter</b><br>used in T-60-11<br>for 10 sample tubes (1,5/2,0 mL, max. Ø 11 mm), set of 6<br>for 20 sample tubes (0.4 mL, max. Ø 6 mm), set of 6 |
| 5804 732.006                 | 022638548                    |  |



## 11.3.11 Rotor S-4-104

| Order no.<br>(international)   | Order No.<br>(North America)   | Description   |
|--|--|---|
| 5820 740.000   | 5820740000   | <b>Rotor S-4-104</b><br>4 × 750 mL<br>incl. 4 round buckets 750 mL for Centrifuges 5810/5810 R  |
| 5825 740.009<br>5825 739.000<br>5825 738.004<br>5825 736.001<br>5825 743.008<br>5825 734.009<br>5825 733.002<br>5825 732.006<br>5825 741.005<br>5825 745.000<br>5825 744.004 | 5825740009<br>5825739000<br>5825738004<br>5825736001<br>5825743008<br>5825734009<br>5825733002<br>5825732006<br>5825741005<br>5825745000<br>5825744004 | <b>Adapter</b><br>used in rotor S-4-104<br>for 50 tubes 1,5 mL/2,0 mL (max. Ø 11 mm), set of 2 pieces<br>for 14 tubes 5 mL (max. Ø 17 mL), set of 2 pieces<br>for 23 round-bottom tubes and blood collection tubes (13 mm x 75 - 100 mm), set of 2 pieces<br>for 20 round-bottom tubes and blood collection tubes (16 mm x 75 - 100 mm), set of 2 pieces<br>for 20 round-bottom tubes and blood collection tubes (17,5 mm x 100 mm), set of 2 pieces<br>for 14 conical tubes 15 mL (max. Ø 17 mm), set of 2 pieces<br>for 7 conical tubes 50 mL (max. Ø 30 mm), set of 2 pieces<br>for 5 skirted conical tubes (max. Ø 30 mm), set of 2 pieces<br>for 1 tube 175 - 250 mL (max. Ø 62 mm), set of 2 pieces<br>for 1 Corning 500 mL Centrifuge Tube (max. Ø 96 mL), set of 2 pieces<br>for 1 wide-neck bottle 750 mL (max. Ø 102 mL), set of 2 pieces |
| 5820 708.000   | 5820708000   | <b>Wide-neck bottle</b><br>for rotor S-4-104<br>750 mL, set of 2  |
| 5820 742.003<br>5820 741.007   | 5820742003<br>5820741007   | <b>Bucket 750 mL</b><br>for rotor S-4-104<br>Set of 2<br>Set of 4   |
| 5820 744.006<br>5820 743.000   | 5820744006<br>5820743000   | <b>Plate bucket (aerosol-tight, capable)</b><br>for rotor S-4-104<br>Set of 2<br>Set of 4   |
| 5820 746.009<br>5820 745.002   | 5820746009<br>5820745002   | <b>Plate bucket</b><br>for rotor S-4-104<br>Set of 2<br>Set of 4  |
| 5820 747.005   | 5820747005   | <b>Aerosol-tight caps for 750 mL rectangular buckets</b><br>for rotor S-4-104<br>Set of 2 pieces  |
| 5820 749.008   | 5820749008   | <b>Spare sealings for 750 mL rectangular buckets</b><br>for rotor S-4-104<br>Set of 4 pieces  |
| 5820 748.001   | 5820748001   | <b>Aerosol-tight caps for plate bucket (aerosol-tight, capable)</b><br>for rotor S-4-104<br>set of 2 pieces   |
| 5820 756.004   | 5820756004   | <b>Plate holder for plate bucket</b><br>for rotor S-4-104 and Rotor A-2-DWP-AT<br>Set of 2 pieces   |
| 5820 750.006   | 5820750006   | <b>Spare sealings for plate buckets (aerosol-tight, capable)</b><br>for rotor S-4-104<br>Set of 4 pieces  |

| Order no.<br>(international) | Order No.<br>(North America) | Description   |
|------------------------------|------------------------------|---|
| 5820 751.002                 | 5820751002                   | <b>MFC bucket</b><br>for rotor S-4-104<br>Set of 2 pieces |

### 11.3.12 Rotor S-4-72

| Order no.<br>(international)                                 | Order No.<br>(North America)                         | Description  |
|--|--|--|
| 5804 746.007   | 5804746007   | <b>Rotor S-4-72</b><br>4 × 250 mL<br>incl. 4 round buckets 250 mL for Centrifuges 5804/5804 R/5810/5810 R  |
| 5804 794.001<br>5804 793.005<br>5804 789.008                 | 5804794001<br>5804793005<br>5804789008               | <b>Adapter</b><br>used in rotor S-4-72<br>for 26 tubes 1,5/2,0 mL (max. Ø 11 mm), set of 2 pieces<br>for 8 tubes 5 mL (max. Ø 17 mm), set of 2 pieces<br>for 14 round-bottom und blood collection tubes (13 mm x 75 - 100 mm), set of 2 pieces                 |
| 5804 791.002   | 5804791002   | for 13 round-bottom und blood collection tubes (16 mm x 75 - 100 mm), set of 2 pieces  |
| 5804 792.009   | 5804792009   | for 12 round-bottom und blood collection tubes (17,5 mm x 100 mm), set of 2 pieces   |
| 5804 783.000<br>5804 784.006<br>5804 785.002<br>5804 787.005 | 5804783000<br>5804784006<br>5804785002<br>5804787005 | for 8 conical tubes 15 mL (max. Ø 17 mm), set of 2 pieces<br>for 4 conical tubes 50 mL (max. Ø 30 mm), set of 2 pieces<br>for 2 conical tubes 15 mL, 50 mL (max. Ø 17 mm, Ø 30 mm), set of 2 pieces<br>for 1 tube 175 - 250 mL (max. Ø 62 mm), set of 2 pieces |
| 5804 747.003   | 5804747003   | <b>Buckets 250 mL</b><br>for Rotor S-4-72<br>Set of 4  |

### 11.3.13 Rotor F-35-48-17

| Order no.<br>(international) | Order No.<br>(North America) | Description  |
|------------------------------|------------------------------|--|
| 5820 771.003                 | 5820771003                   | <b>Rotor F-35-48-17</b><br>incl. 24 steel sleeves and adapter<br>for 24 x 15 mL tubes for Centrifuges 5804/5804 R/5810/5810 R  |
| 5820 772.000                 | 5820772000                   | <b>Rotor F-35-48-17</b><br>incl. 48 steel sleeves and adapter<br>for 48 x 15 mL tubes for Centrifuges 5804/5804 R/5810/5810 R  |
| 5820 774.002                 | 5820774002                   | <b>Steel sleeves incl. adapter</b><br>for Rotor F-35-48-17<br>for 36 conical tubes 15 mL and 48 round-bottom and blood collection tube (max. Ø 16 mm x 100 mm), set of 24 pieces |

### 11.3.14 FA-45-48-11 rotor

| Order no.<br>(international) | Order No.<br>(North America) | Description   |
|------------------------------|------------------------------|---|
| 5820 760.001                 | 5820760001                   | <b>Rotor FA-45-48-11</b><br>aerosol-tight, for 48 x 1.5/2 mL tubes, incl. aerosol-tight rotor lid for Centrifuges 5804/5804 R/5810/5810 R |
| 5820 761.008                 | 5820761008                   | <b>Spare lid, aerosol-tight</b><br>for rotor FA-45-48-11<br>1 piece   |

| Order no.<br>(international) | Order No.<br>(North America) | Description  |
|------------------------------|------------------------------|--|
| 5820 767.006                 | 5820767006                   | <b>Seal for rotor lid</b><br>FA-45-24-11-Kit (5427 R/5430/5430 R), FA-45-48-11, FA-45-20-17 (5804/5804 R/<br>5810/5810 R)<br>Set of 5 pieces |

### 11.3.15 Rotor FA-45-20-17

| Order no.<br>(international) | Order No.<br>(North America) | Description   |
|------------------------------|------------------------------|---|
| 5820 765.003                 | 5820765003                   | <b>Rotor FA-45-20-17</b><br>aerosol-tight, for 20 x 5 mL tubes, incl. aerosol-tight rotor lid for Centrifuges<br>5804/5804 R/5810/5810 R  |
| 5820 766.000                 | 5820766000                   | <b>Spare lid, aerosol-tight</b><br>for rotor FA-45-20-17<br>1 piece   |
| 5820 767.006                 | 5820767006                   | <b>Seal for rotor lid</b><br>FA-45-24-11-Kit (5427 R/5430/5430 R), FA-45-48-11, FA-45-20-17 (5804/5804 R/<br>5810/5810 R)<br>Set of 5 pieces  |
| 5820 768.002<br>5820 769.009 | 5820768002<br>5820769009     | <b>Adapter</b><br>used in rotor FA-45-12-17 (5427 R), FA-45-16-17 (5430/5430 R), FA-45-20-17<br>(5804/5804 R/5810/5810 R)<br>for 1 tube 1,5 mL/2,0 mL (max. Ø 11 mm), set of 10 pieces<br>for 1 Cryo tube, set of 10 pieces |
| 5820 770.007                 | 5820770007                   | <b>Adapter</b><br>used in Rotor FA-45-12-17 (5427 R), FA-45-16-17 (5430/5430 R), FA-45-20-17<br>(5804/5804 R/5810/5810 R)<br>for 1 HPLC vial, set of 10 pieces  |

### 11.3.16 Miscellaneous

| Order no.<br>(international) | Order No.<br>(North America) | Description  |
|------------------------------|------------------------------|--|
| 5804 720.008                 | 022639021                    | <b>Rotor stand</b><br>suitable for all rotors of Centrifuge 5804/5804 R/5810/5810 R        |
| 5810 350.050                 | 022634330                    | <b>Pivot grease</b><br>Tube 20 mL  |
| 5810 350.018                 | 022664166                    | <b>Rotor key</b><br>Standard   |
| 5811 001.068                 | 022662678                    | <b>Tray for condensation water</b>   |
| on request<br>on request     | on request<br>on request     | <b>Conversion kit for RS 232 interface</b><br>For Centrifuge 5804<br>For Centrifuge 5804 R |

### Power cable for Centrifuge 5804 and Centrifuge 5810

| Order no.<br>(international) | Order No.<br>(North America) | Description                                     |
|------------------------------|------------------------------|---|
| 0113 200.111                 | –                            | <b>Mains/power cable</b><br>230 V/50 Hz, Europe |
| 0013 594.490                 | –                            | 230 V/50 Hz, GB/HK                              |
| 0013 613.952                 | –                            | 230 V/50 Hz, CN                                 |
| 0013 592.454                 | –                            | 230 V/50 Hz, AUS                                |
| 0113 200.863                 | 022664999                    | 120 V/60 Hz, USA                                |
| 5804 652.002                 | –                            | 202 V, Japan                                    |
| 0013 613.973                 | –                            | 230 V/50 Hz, ARG                                |

### Power cable for Centrifuge 5804 R and Centrifuge 5810 R

| Order no.<br>(international) | Order No.<br>(North America) | Description                                     |
|------------------------------|------------------------------|---|
| 0113 204.486                 | –                            | <b>Mains/power cable</b><br>230 V/50 Hz, Europe |
| 0113 204.680                 | –                            | 230 V/50 Hz, GB/HK                              |
| 0013 613.953                 | –                            | 230 V/50 Hz, CN                                 |
| 0113 204.699                 | –                            | 230 V/50 Hz, AUS                                |
| 0113 200.863                 | 022664999                    | 120 V/60 Hz, USA                                |
| 0113 205.105                 | –                            | 230 V/50 Hz, ARG                                |
| 5821 609.005                 | –                            | <b>Mains/power cable</b><br>202 V, Japan        |

### Connecting cable for Centrifuge 5804 / 5804 R and 5810 / 5810 R with rolling cabinet with transformer

| Order no.<br>(international) | Order No.<br>(North America) | Description   |
|------------------------------|------------------------------|---|
| 5821 851.094                 |                              | <b>Cable for rolling cabinet - centrifuge</b><br>15 A |

# EG-Konformitätserklärung EC Conformity Declaration

Das bezeichnete Produkt entspricht den einschlägigen grundlegenden Anforderungen der aufgeführten EG-Richtlinien und Normen. Bei einer nicht mit uns abgestimmten Änderung des Produktes oder einer nicht bestimmungsgemäßen Anwendung verliert diese Erklärung ihre Gültigkeit.

The product named below fulfils the relevant fundamental requirements of the EC directives and standards listed. In the case of unauthorized modifications to the product or an unintended use this declaration becomes invalid.

Produktbezeichnung, Product name:

Centrifugen 5804 / 5804 R , 5810 / 5810 R

einschließlich Zubehör / including accessories

Produkttyp, Product type:

Laborzentrifugen / Laboratory Centrifuges

Einschlägige EG-Richtlinien/Normen, Relevant EC directives/standards:

2006/95/EG, EN 61010-1, EN 61010-2-20

2004/108/EG, EN 61000-6-1, EN 61000-3-2, EN 61000-3-3, EN 61326-1

98/79/EG, EN 14971, EN 61010-2-101, EN 61326-2-6, EN 62366, EN 18113-3

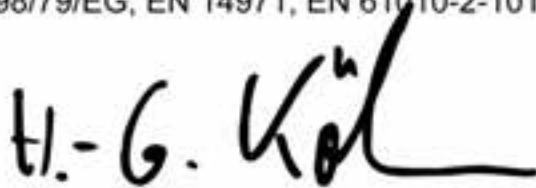

Vorstand, Board of Management:

14.08.2012

Hamburg, Date:



Projektmanagement, Project Management:

**eppendorf**



Eppendorf AG · Barkhausenweg 1 · 22339 Hamburg · Germany



**Underwriters Laboratories Inc.®**

# CERTIFICATE OF COMPLIANCE

**CERTIFICATE NUMBER:** 060203 - E215059

**ISSUE DATE:** February 06, 2003

Page 1 of 1

**Issued to:** Eppendorf A G - Dept Mp  
Barkhausenweg 1  
D-22339 Hamburg Germany

**Report Reference:** E215059, February 19, 1999

**This is to Certify that representative samples of:** Laboratory Centrifuges, Models 5804, 5804R, 5810, 5810R.

Have been investigated by Underwriters Laboratories Inc.® in accordance with the Standard(s) indicated on this Certificate.

**Standard(s) for Safety:** UL 3101-1 - Electrical Equipment for Laboratory Use; Part 1: General Requirements  
UL 3101-2-20 - Electrical Equipment for Laboratory Use, Part 2: Laboratory Centrifuges  
CSA C22.2 No. 1010-1 - Safety Requirements for Electrical Equipment for Measurement, Control, and Laboratory Use, Part I: General Requirements

**Additional Information:** Electrical Ratings:

| Ratings | Voltage | Frequency(Hz) | Power(W) |
|---------|---------|---------------|----------|
| 5804    | 120     | 60            | 850      |
| 5804R   | 120     | 60            | 1400     |
| 5810    | 120     | 60            | 950      |
| 5810R   | 120     | 60            | 1650     |

Only those products bearing the UL Listing Mark for the US and Canada should be considered as being covered by UL's Listing and Follow-Up Service meeting the appropriate requirements for US and Canada.

The UL Listing Mark for the US and Canada generally includes: the UL in a circle symbol with "C" and "US" identifiers;  the word "LISTED"; a control number (may be alphanumeric) assigned by UL; and the product category name (product identifier) as indicated in the appropriate UL Directory.

### **LOOK FOR THE UL LISTING MARK ON THE PRODUCT**

Engineer:  
  
Bogdan Maliszewski - Senior Project Engineer  
UL International Germany GmbH

Review Engineer:  
  
Daniel Bejnarowicz, Engineering Group Leader  
UL International Germany GmbH

Pursuant to the Corporate Services Agreement between UL International Germany GmbH and Underwriters Laboratories Inc. ("UL"), UL hereby accepts and issues this Certificate of Compliance. For questions in Germany, you may call 49 6102 3690.



## Certificate of Containment Testing

### Containment Testing of Swing Out Rotor with Buckets [A-2-DWP-AT (5820 710.004-00)] and Autoclaved (x50) lids in the Eppendorf Centrifuge 5810

**Report No. 104-09 B**

**Report prepared for:** Eppendorf AG, Hamburg, Germany  
**Issue Date:** 31<sup>st</sup> March 2010 (amended 17<sup>th</sup> Aug 10)

#### Test Summary

Swing out rotor with buckets [A-2-DWP-AT (5820 710.004-00)] and autoclaved (x50) lids was containment tested in the Eppendorf 5810 centrifuge, in accordance with Annex AA of IEC 1010-2-20. The sealed bucket was shown to contain the spill of micro-organisms and therefore prevent any release.

**Report Written By**

A handwritten signature in blue ink, appearing to be "Mlac", written over a horizontal dashed line.

**Report Authorised By**

A handwritten signature in blue ink, consisting of several sharp, overlapping strokes, written over a horizontal dashed line.



## Certificate of Containment Testing

### **Containment Testing of Rotor A-4-44 and Sealed Buckets and Lids (Cap 100, Order no. 5804 712.005) in the Eppendorf Centrifuge 5810**

**Report No. 352-97 (Part 1)**

**Report prepared for:** Eppendorf AG, Hamburg, Germany  
**Issue Date:** Original report issued 8<sup>th</sup> September 1997  
Certificate issued 18<sup>th</sup> October 2010

#### **Test Summary**

Rotor A-4-44 and sealed buckets and lids (Cap 100, Order no. 5804 712.005) were containment tested in the Eppendorf Centrifuge 5810, using Annex AA of IEC 1010-2-020. The sealed buckets were shown to contain the spill within the centrifuge.

**Report Written By**

*Anna May*

**Report Authorised By**

*[Signature]*





## Certificate of Containment Testing

# Containment Testing of Rotor FA-45-6-30 [(5820 715.103-00) and autoclaved lid (x50)] in the Eppendorf Centrifuge 5810R

**Report No. 40-10B**

**Report prepared for:** Eppendorf AG, Hamburg, Germany  
**Issue Date:** 19<sup>th</sup> July 2010 (amended 17<sup>th</sup> Aug 10)

### Test Summary

Rotor FA-45-6-30 (5820 715.103-00) and autoclaved lid (x50) was containment tested in the Eppendorf centrifuge 5810R, in accordance with Annex AA of IEC 1010-2-20. The sealed rotor was shown to contain the spill of micro-organisms and therefore prevent any release.

**Report Written By**

A handwritten signature in blue ink, appearing to be "Hla", written over a horizontal dashed line.

**Report Authorised By**

A handwritten signature in blue ink, appearing to be "A. J. ...", written over a horizontal dashed line.



## Certificate of Containment Testing

### **Containment Testing of Rotor A-4-62 and Sealed Buckets and Lids (Cap 250/1, Order no. 5810 710.006) in the Eppendorf Centrifuge 5810**

**Report No. 352-97 (Part 2)**

**Report prepared for:** Eppendorf AG, Hamburg, Germany  
**Issue Date:** Original report issued 8<sup>th</sup> September 1997  
Certificate issued 18<sup>th</sup> October 2010

#### **Test Summary**

Rotor A-4-62 and sealed buckets and lids (Cap 250/1, Order no. 5810 710.006) were containment tested in the Eppendorf Centrifuge 5810, using Annex AA of IEC 1010-2-020. The sealed buckets were shown to contain the spill within the centrifuge.

**Report Written By**

Anna May

**Report Authorised By**

[Signature]

## Certificate of Containment Testing

400ml Rectangular Buckets fitted with  
Sealed Caps in Eppendorf Centrifuge 5810  
containing Rotor A-4-81

**Report No. 1000-06**

**Report prepared for:** Eppendorf AG, Hamburg, Germany  
**Issue Date:** 21<sup>st</sup> March 2006

### Test Summary

400 ml rectangular buckets fitted with sealed caps were  
containment tested in the Eppendorf centrifuge 5810  
containing rotor A-4-81, using Annex AA of IEC 1010-2-20.  
The buckets were shown to contain a large spill.

**Report Written By**



**Report Authorised By**

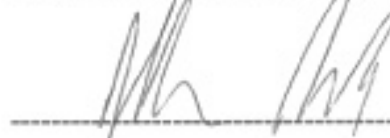



## Certificate of Containment Testing

### Containment Testing of Rotor FA-45-48-11(5820 760.109-00) in the Eppendorf 5810/R Bench Top Centrifuge

Report No. 199-12

**Report Prepared For:** Eppendorf AG, Hamburg, Germany

**Issue Date:** 12<sup>th</sup> September 2012

#### Test Summary

Rotor FA-45-48-11 (5820 760.109-00) was containment tested in the Eppendorf 5810/R bench top centrifuge, using Annex AA of IEC 1010-2-20. The sealed rotor was shown to contain a spill within the centrifuge

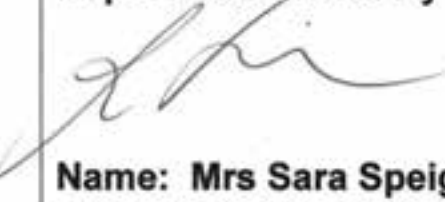
|  |  |
|--|--|
| <b>Report Written By</b><br><br><b>Name: Miss Anna Moy</b><br><b>Title: Biosafety Scientist</b> | <b>Report Authorised By</b><br><br><b>Name: Mrs Sara Speight</b><br><b>Title: Senior Biosafety Scientist</b> |
|--|--|



## Certificate of Containment Testing

### Containment Testing of Rotor S-4-104 with Round Buckets (5820 741.007-00) in the Eppendorf 5810/R Bench Top Centrifuge

Report No. 196-12 A

**Report Prepared For:** Eppendorf AG, Hamburg, Germany

**Issue Date:** 12<sup>th</sup> September 2012

#### Test Summary

Rotor S-4-104 with Round Buckets (5820 741.007-00) was containment tested in the Eppendorf 5810/R bench top centrifuge, using Annex AA of IEC 1010-2-20. The sealed rotor was shown to contain a spill within the centrifuge

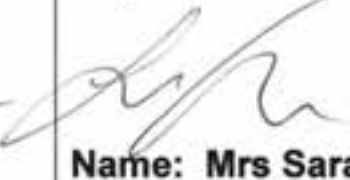
|  |  |
|--|--|
| <b>Report Written By</b><br><br><b>Name: Miss Anna Moy</b><br><b>Title: Biosafety Scientist</b> | <b>Report Authorised By</b><br><br><b>Name: Mrs Sara Speight</b><br><b>Title: Senior Biosafety Scientist</b> |
|--|--|





Evaluate your operating manual

[www.eppendorf.com/manualfeedback](http://www.eppendorf.com/manualfeedback)

# eppendorf

**Your local distributor: [www.eppendorf.com/worldwide](http://www.eppendorf.com/worldwide)**

Eppendorf AG · 22331 Hamburg · Germany · Tel: +49 40 53801-0 · Fax: +49 40 538 01-556 · E-mail: [eppendorf@eppendorf.com](mailto:eppendorf@eppendorf.com)

Eppendorf North America, Inc. · 102 Motor Parkway · Hauppauge, N.Y. 11788-5178 · USA

Tel: +1 516 334 7500 · Toll free phone: +1 800-645-3050 · Fax: +1 516 334 7506 · E-mail: [info@eppendorf.com](mailto:info@eppendorf.com)

**Application Support** Europe: Tel: +49 1803 666 789 (Preis je nach Tarif im Ausland; 9 ct/min aus dem dt. Festnetz; Mobilfunkhöchstpreis 42 ct/min)  
[support@eppendorf.com](mailto:support@eppendorf.com)

North America: Tel: +1 800 645 3050 · E-mail: [techserv@eppendorf.com](mailto:techserv@eppendorf.com)

Asia Pacific: Tel: +60 3 8023 6869 · E-mail: [support\\_asiapacific@eppendorf.com](mailto:support_asiapacific@eppendorf.com)